

DESCRIPTION

The Sure-Lites SELIN industrial series is a UL 924 code compliant emergency light designed to reduce total egress system cost and maintenance as well as ensure reliability in an industrial or wet location environment. It is designed to run for a minimum of 90 minutes during a power outage. Key features include a long life LED source with egress coverage up to 60 feet, a nickel cadmium battery and self-diagnostics which automates the NFPA required testing. The fixture is NEMA 4X, IP66, Title 20 compliant and has a chemically resistant fiberglass housing. This series offers remote capability from 4 watts to 10 watts and is compatible with the Sure-Lites SRP/SRM remote series.

| | | | |
|--------------------|--|-------------|--|
| Catalog # | | Type | |
| Project | | | |
| Comments | | Date | |
| Prepared by | | | |

SPECIFICATION FEATURES

ELECTRICAL

- Dual Voltage Input
120/277 VAC, 60Hz
- Brownout circuit
- Low voltage disconnect
- Overload / Short Circuit protection
- 4.8V Battery back-up
- Self-diagnostic
- Remote capability

HOUSING CONSTRUCTION

- UL listed NEMA 4X fiberglass
- Watertight and corrosion resistant
- Gasketed; internally hinged front cover
- Grey finish
- All units come standard with a breather vent

WARRANTY

- Five-year product warranty
- Prorated seven-year battery warranty

CODE COMPLIANCE

- UL924 wet location listed for 0 °C to 40 °C operation
- Life Safety NFPA 101
- NEMA 4X / IP66
- NEC/OSHA/NSF
- Most State & Local Codes
- California Energy Code Compliant

BATTERY

- Sealed Nickel Cadmium
- Full Recharge Time, 24 hours (max.)
- 0 ° to 40 °C (32 ° to 104 °F)



**SELIN25/SELIN50/
SELIN60**

**SELIN Emergency
Light**

**LED Emergency Light
Self-Diagnostics
SELIN
Remote Capacity
Wet Location
NEMA 4X
IP 66**

DIMENSIONS

SELIN25/SELIN50/SELIN60

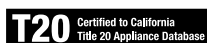
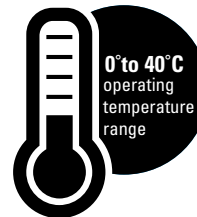
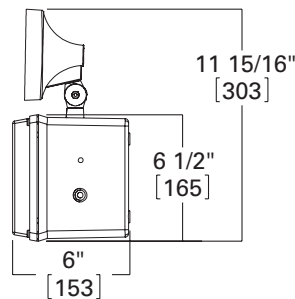
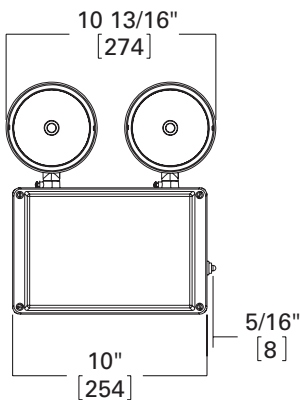
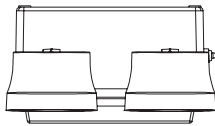

CATALOG LOGIC

SAMPLE NUMBER: SELIN25R10SD, SELIN50R7SD, SELIN60R4SD

| Series | Spacing | Battery | Remote Capacity | Self-Diagnostic | Full Catalog |
|-----------------------------|--------------|------------|-----------------|---------------------------------|--------------|
| SELIN = LED Emergency Light | 25 = 25 feet | __ = NiCad | R10 = 10 watts | SD = Self-Diagnostic (standard) | SELIN25R10SD |
| | 50 = 50 feet | __ = NiCad | R7 = 7 watts | SD = Self-Diagnostic (standard) | SELIN50R7SD |
| | 60 = 60 feet | __ = NiCad | R4 = 4 watts | SD = Self-Diagnostic (standard) | SELIN60R4SD |

ELECTRICAL CHARACTERISTICS DURING CHARGING MODE

SELIN25 / SELIN50 / SELIN60

| Model | Power (W) | Current (A) | PF | Power (W) | Current (A) | PF |
|--------------|-----------|-------------|------|-----------|-------------|------|
| Voltage | 120V | | | 277V | | |
| SELIN25R10SD | 2 | 0.3 | 0.07 | 1.8 | 0.2 | 0.03 |
| SELIN50R7SD | 2 | 0.3 | 0.07 | 1.8 | 0.2 | 0.03 |
| SELIN60R4SD | 2 | 0.3 | 0.07 | 1.8 | 0.2 | 0.03 |

Emergency Egress Coverage; fixture spacing

| Catalog Number | Output Lumens | 0.1fc minimum | | 1fc minimum | |
|----------------|---------------|-----------------|----------------|-----------------|----------------|
| | | 7.5 foot height | 20 foot height | 7.5 foot height | 20 foot height |
| SELIN25R10SD | 108 | 25 feet | 12 feet | 14 feet | 12 feet |
| SELIN50R7SD | 218 | 50 feet | 30 feet | 21 feet | 20 feet |
| SELIN60R4SD | 309 | 60 feet | 52 feet | 24 feet | 30 feet |

REMOTE SYSTEM DESIGN GUIDELINES

SELIN25 / SELIN50 / SELIN60

| | | SEL Series Outdoor Capable Remotes | | | | | | Value Proposition |
|----------------|--------|------------------------------------|------------|------------|---------------------|----------------|----------------|-------------------|
| Series | SRPA | Single Head Remotes | | | Double Head Remotes | | | |
| Catalog number | SRPA29 | SRP/ SRM13 | SRP/ SRM25 | SRP/ SRM30 | SRP25D/ SRM25D | SRP50D/ SRM50D | SRP60D/ SRM60D | |
| Watts Consumed | 3.5 | 1.25 | 2.5 | 4.1 | 2.5 | 5 | 8.2 | |

| Catalog Number | Remote Watts Available | # of SRPA29 remotes fixture will power | # of SRP/ SRM13 remotes fixture will power | # of SRP/ SRM25 remotes fixture will power | # of SRP/ SRM30 remotes fixture will power | # of SRP25D/ SRM25D remotes fixture will power | # of SRP50D/ SRM50D remotes fixture will power | # of SRP60D/ SRM60D remotes fixture will power | Total Potential Egress Coverage |
|----------------|------------------------|--|--|--|--|--|--|--|---------------------------------|
| SELIN25R10SD | 10 | 2 | 8 | 4 | 2 | 4 | 2 | 1 | 125 feet |
| SELIN50R7SD | 7 | 2 | 5 | 2 | 1 | 2 | 1 | NA | 115 feet |
| SELIN60R4SD | 4 | 1 | 3 | 1 | NA | 1 | NA | NA | 99 feet |



SRP



SRPD



SRM



SRMD



SRPA WHITE



SRPA BLACK



SRPA BRONZE



SRPA SILVER

PHOTOMETRY

SELIN25R10SD

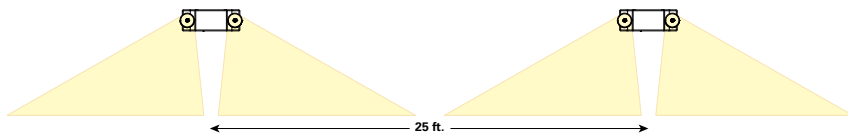
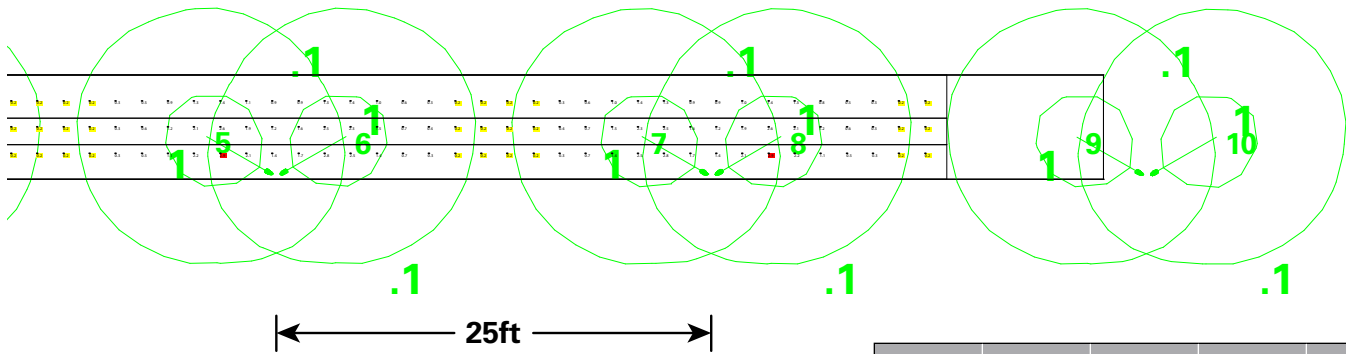

| X | Y | Z | Orient | Tilt |
|-------|-------|-----|--------|------|
| -0.5 | 0.25 | 7.5 | 125 | 27 |
| 0.5 | 0.25 | 7.5 | 55 | 27 |
| 16.5 | 0.211 | 7.5 | 125 | 27 |
| 17.5 | 0.212 | 7.5 | 55 | 27 |
| 33.5 | 0.172 | 7.5 | 125 | 27 |
| 34.5 | 0.173 | 7.5 | 55 | 27 |
| 50.5 | 0.132 | 7.5 | 125 | 27 |
| 51.5 | 0.135 | 7.5 | 55 | 27 |
| 67.5 | 0.093 | 7.5 | 125 | 27 |
| 68.5 | 0.096 | 7.5 | 55 | 27 |
| 84.5 | 0.054 | 7.5 | 125 | 27 |
| 85.5 | 0.058 | 7.5 | 55 | 27 |
| 101.5 | 0.015 | 7.5 | 125 | 27 |
| 102.5 | 0.019 | 7.5 | 55 | 27 |

SELIN50R7SD

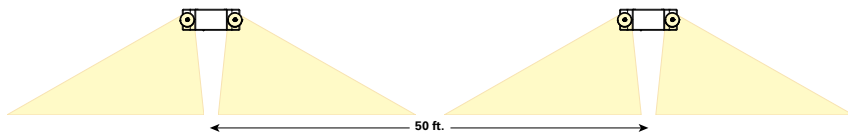
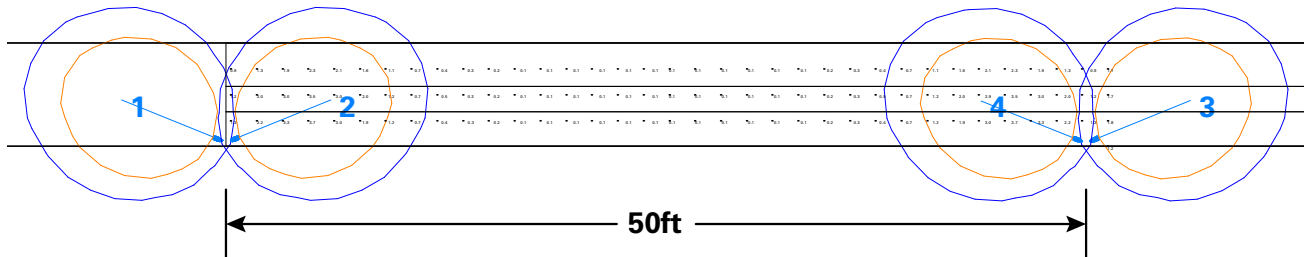

| X | Y | Z | Orient | Tilt |
|-------|-------|-----|--------|------|
| 24.25 | 0.33 | 7.5 | 158 | 40 |
| 24.75 | 0.33 | 7.5 | 22 | 40 |
| 74.75 | 0.3 | 7.5 | 22 | 40 |
| 74.25 | 0.292 | 7.5 | 158 | 40 |

***The "Rule of Thumb" spacing guidelines are designed to achieve 1 foot-candle average and 0.1 foot-candle minimum with a 40:1 maximum/minimum ratio. The corridor used is 100 feet long, 9 foot ceiling with a 6 foot wide walkway and 3 foot path of egress. The reflectances are 80% ceiling, 50% walls and 20% floors. The fixture mounting height is 7.5 feet. Cooper Lighting Solutions assumes no responsibility for local requirements or specific project variables. This is a guideline to be used as a design aid, not as guarantee of any code compliance.

PHOTOMETRY

SELIN60R4SD

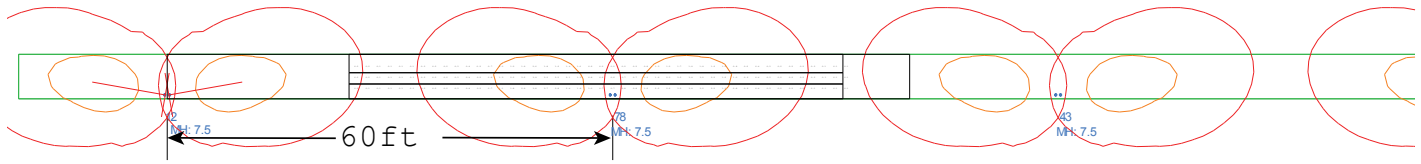

| X | Y | Z | Orient | Tilt |
|--------|-----|-----|--------|------|
| -0.25 | 0.5 | 7.5 | 170 | 57 |
| 0.25 | 0.5 | 7.5 | 10 | 57 |
| 120.25 | 0.5 | 7.5 | 10 | 57 |
| 119.75 | 0.5 | 7.5 | 170 | 57 |
| 59.75 | 0.5 | 7.5 | 170 | 57 |
| 60.25 | 0.5 | 7.5 | 10 | 57 |
| 180.25 | 0.5 | 7.5 | 10 | 57 |
| 179.75 | 0.5 | 7.5 | 170 | 57 |

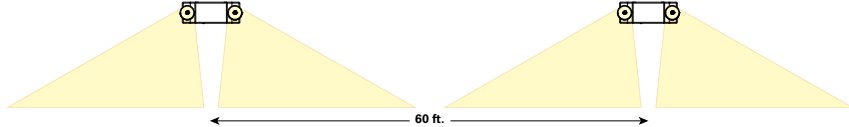

***The "Rule of Thumb" spacing guidelines are designed to achieve 1 foot-candle average and 0.1 foot-candle minimum with a 40:1 maximum/minimum ratio. The corridor used is 100 feet long, 9 foot ceiling with a 6 foot wide walkway and 3 foot path of egress. The reflectances are 80% ceiling, 50% walls and 20% floors. The fixture mounting height is 7.5 feet. Cooper Lighting Solutions assumes no responsibility for local requirements or specific project variables. This is a guideline to be used as a design aid, not as guarantee of any code compliance.

TECHNICAL DATA

Self-Diagnostics

The self-diagnostic software will automatically perform all tests required by UL924, and NFPA101 and will systematically calibrate itself in the field; thus reducing installation labor and eliminating manual calibration errors. The system indicates the status of the emergency light at all times using the LED indicator. A 90 minute battery power (emergency mode) simulation test will occur once every 12 months. A 30 second battery power simulation test will occur every 30 days.

The Solid-State microprocessor based system has the ability to accurately detect and warn of system failures, plus it incorporates all of the standard electronic features that sets Sure-Lites apart from its competition.

Remote Capability

The SELIN series offers remote capability from 4 watts to 10 watts. This enables the ability to power the Sure-Lites SRP/SRM/SRPA series remotes to create an emergency system capable of covering up to 125 feet. The Sure-Lites SRP/SRM/SRPA remotes are UL listed for wet locations and are rated for temperatures from - 30 °C to 60 °C.

Low Voltage Disconnect

The low-voltage circuitry disconnects the lighting load to protect the battery after run times in excess of the 90-minute UL limit. The disconnect remains in effect until normal utility power is restored preventing deep battery discharge.

Brownout Circuit

The brownout circuit on the SELIN emergency light monitors the flow of AC current to the unit and activates the emergency light heads when a predetermined reduction of AC power occurs.

Laser Test

The Self-Diagnostic option include a laser pointer testing capability. Activation of the photocell test button with a laser pointer will simulate loss of AC power and engage the emergency operation of the exit and emergency heads.

Warranty

SELIN units are backed by a five-year warranty on the fixtures and a seven-year prorated battery warranty.



Laser tester

Part Number = LASER
(sold separately)

SELF-DIAGNOSTIC TESTING OPERATIONS

The Sure-Lites self-diagnostics is continuously monitoring your emergency fixture, and will signal any failure through the 3 color indicator LED.

Initial Operation:

When the unit is first powered up it will go into a 24 hour fast charge and the indicator LED will pulse green. Once the unit has fully charged it will perform a self calibration. After self calibration, the LED will change to steady green indicating the unit is fully charged and float charging the battery to maintain readiness.

Automatic Testing:

The unit will perform a battery capacity, lamp/LED, and charge circuit test every 30 days for 30 seconds. During this time, the indicator LED will change to a steady yellow. It will perform a full battery capacity (90 minute) test once per year. During this time, the indicator LED will change to a blinking yellow.

Manual Testing:

- 10 Second "Installation" test – Press and release the test button once during fast charge (blinking green) to initiate a 10 second quick test. The sign will switch to emergency mode for 10 seconds allowing the installer to verify proper installation of the unit, and the LED indicator will turn solid yellow.
- 30 Second Test - Press and release the test button once during float charge (steady green). The indicator LED will turn steady yellow to indicate the unit is performing a 30 second test of the batteries and lamps/LEDs.
- 90 Minute Test - Press and release the test button a second time during a 30 second test (steady yellow) to change to a 90 minute test. During this test, the LED indicator will change to blinking yellow, and the circuit will perform a full battery capacity, charge circuit, and LED test.
- Canceling Test – Press and release the test button during the 90 minute test (flashing yellow) to return the fixture to its original state (fast charge or float charge)

Laser Test:

The SEL SD products are equipped with a Laser Test function that allows the unit to be manually tested without the need to physically press the test button. Shining a laser pointer in the hole marked "LASERTEST" on the bottom of the unit has the same effect as a press and release of the test button.

Clearing Failure Codes:

- A battery failure (LED two blink red) can be cleared by replacing the battery. Disconnecting the battery and AC power, or performing a full 90 minute discharge will reset the error code, however, it will return if the battery is faulty
- Charge Circuit (LED three blink red) and lamp/LED failure (LED four blink red) will clear when the unit successfully passes a manual or automatic 30 second test.

SELF DIAGNOSTIC TESTING OPERATIONS

Indicators:

- LED Off - No power to unit, emergency mode.
- LED Steady Green - Unit is fully charged and is float charging the battery to maintain readiness.
- LED Green Pulse - Unit is in a 24 hour fast charge of the battery.
- LED Two Blink Red - Battery has failed a capacity test, or the battery is disconnected. See "Clearing Failure Codes" above.
- LED Three Blink Red - Battery charge circuit has failed. See "Clearing Failure Codes" above.
- LED Four Blink Red - Lamps have burned out, or on an EXIT/Combo, 50% or more of the LEDs have failed. See "Clearing Failure Codes" above.
- LED Steady Yellow - 30 second test or 10 second quick test (Fast Charge only).
- LED Blinking Yellow - 90 minute test.

Maintenance:

None required. Replace the batteries as needed according to ambient conditions. However, we recommend that the equipment be tested regularly in accordance with local codes.

