

Project:

Type:

Prepared By:

Date:



UPC: 019813749860



Features and Benefits

- Energy efficient replacement for incandescent and halogen Small diameter reflectors
- Constructed from durable materials which lowers risk of breakage
- Rated for use in enclosed and open fixtures in dry or damp locations
- Single optic and full face lens for precise beam angle control
- Longer lifespan compared to legacy equivalents minimizes replacement and maintenance costs
- ENERGY STAR Compliant, UL Listed

Technical Specifications

Performance

Product Type:

PAR

Input Wattage:

6.5W

Lumens (Nominal):

500lm

Efficacy:

76.9lm/W

L70 Lifespan:

25,000-Hour LED lifespan based on IES LM-70 results

Wattage Equivalency:

50W Halogen

Compliance

UL Listed:

Suitable for damp locations

Enclosed Fixtures:

Suitable for use in enclosed fixtures

LED Characteristics

Color Temperature:

5000K

Color Accuracy (CRI):

80 CRI

Electrical

Power Factor:

0.7

Dimmable:

Yes

Operating Temperature:

-20°C to 45°C (-4°F to 113°F)

Input Voltage:

120V

Operating Frequency:

60 Hz

Construction

Bulb Shape:

PAR16

Base Type:

E26 Edison

Enclosure Material:

Plastic

Optical

Beam Angle:

40°

Other

Warranty:

RAB warrants that our LED products will be free from defects in materials and workmanship for a period of four (4) years from the date of delivery to the end user, including coverage of light output, color stability, driver performance and fixture finish. RAB's warranty is subject to all terms and conditions found at rablighting.com/warranty.

Case and Pallet Dimensions

	QTY	LENGTH (in)	WIDTH (in)	HEIGHT (in)
CASE	12	8.6	6.5	4
PALLET	4320	44.49	40.47	43.94

Dimension

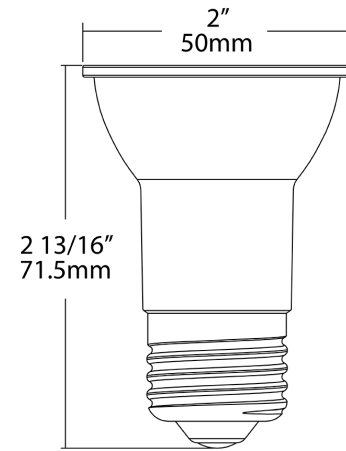

Light Distribution

