



KT-WPLED40-M2-8XX-VDIM

ARCHITECTURAL FULL-CUTOFF LED WALL PACK

DESCRIPTION

Architectural 40W Full-Cutoff LED Wall Pack | 120-277V Input | 4000-5000K | Medium Housing | Bronze Finish | Wide Optic Lens

APPLICATION

Building mount for exterior illumination (perimeters, pathways, loading docks, and other general security lighting requirements)



10 YEAR
LIMITED WARRANTY

PRODUCT FEATURES

- Architectural full cutoff design that improves building appearance and optimizes functional light distribution
- Heavy duty die cast aluminum housing with (5) 1/2" threaded conduit hubs: (1) on back and (1) on all four sides
- Powered by Keystone 0-10V dimming LED drivers
- Dark Sky friendly performance that eliminates undesirable sky glow and glare
- Features one translucent 3/4" threaded plug with anti-yellowing agent for use with photocell accessory KT-WPLED-PS-UV-KO, sold separately
- Precision-crafted optical lens that provides wide distribution pattern ideal for increased fixture spacing and uniformity
- Covers footprint of mid-size HID wallpacks
- Ambient operating temperature: -40°C/-40°F to 50°C/122°F
- UL Certified for wet locations; IP65 rated
- Fixture impact rating IK08
- Power Factor: >0.95
- THD: <20%
- LED chip lifetime: L70 >100,000 hrs @ 25°C/77°F ambient fixture temperature
- Meets FCC Part 15, Part B, Class A standards for conducted and radiated emissions
- **Compatible with Keystone LED Emergency Backups. See Accessories page for more details**

PRODUCT SPECIFICATIONS

Catalog Number	Wattage	Lumens	Lumens Below 90°	Dimming	CCT	Efficacy	CRI	Housing Color	Input Voltage	Rated Life	Legacy Equivalent
KT-WPLED40-M2-840-VDIM	40W	5000	4965	0-10V	4000K	125 lm/W	>80	Bronze	120-277V	50,000 hrs	175W MH
KT-WPLED40-M2-850-VDIM		5200	5160		5000K	130 lm/W					

KT-WPLED40-M2-8XX-VDIM

ARCHITECTURAL FULL-CUTOFF LED WALL PACK

PHOTOMETRIC SPECIFICATIONS

ISOCANDELA PLOT

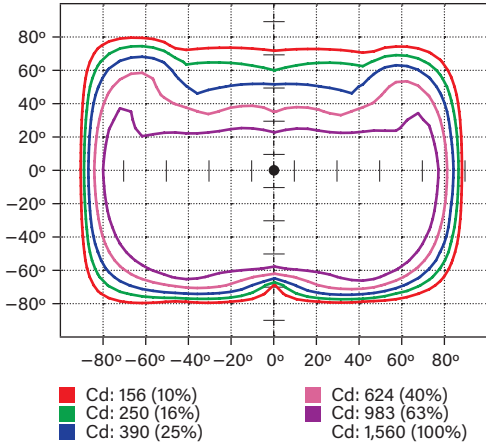

LUMINOUS INTENSITY DISTRIBUTION

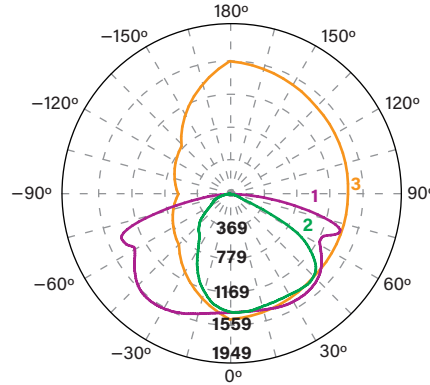

Average diffuse angle (50%): 125.1°

- 1 Violet C0 - C180
- 2 Green C90 - C270
- 3 Orange G36

Unit: cd

FLUX DISTRIBUTION

Zone	Lumens	% Luminaire
Forward Light	3,171 lm	62.0%
0°-30°	596 lm	11.6%
30°-60°	1,594 lm	31.2%
60°-80°	912 lm	17.8%
80°-90°	70 lm	1.4%
Back Light	1,905 lm	37.2%
0°-30°	514 lm	10.1%
30°-60°	876 lm	17.1%
60°-80°	460 lm	9.0%
80°-90°	54 lm	1.1%
Up Light	39 lm	0.8%
90°-100°	3 lm	0.1%
100°-180°	36 lm	0.7%

BUG* Rating

Asymmetrical Luminaire Types

Type I, II, III, IV B2 U2 G1

Quadrilateral Symmetrical Luminaire Types

Type V, Area Light B2 U2 G1

* Backlight, Uplight, Glare

MOUNTING

Side view

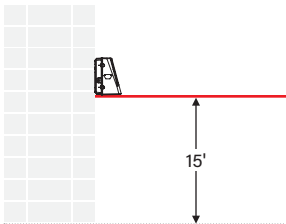

LIGHT DISTRIBUTION PATTERN

Isometric view from above; Luminaire mounted at 15'

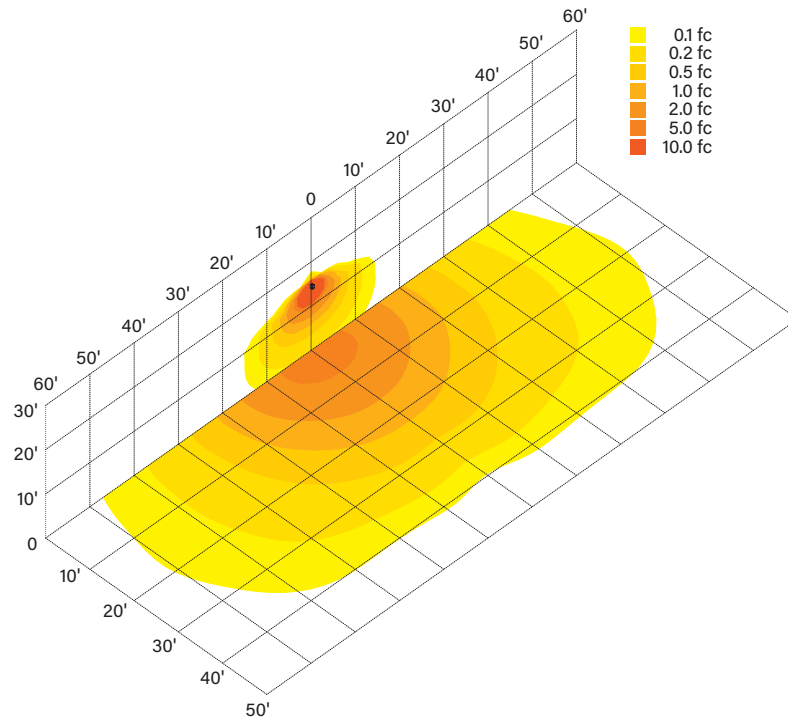

KT-WPLED40-M2-8XX-VDIM
 ARCHITECTURAL FULL-CUTOFF LED WALL PACK

PHYSICAL SPECIFICATIONS

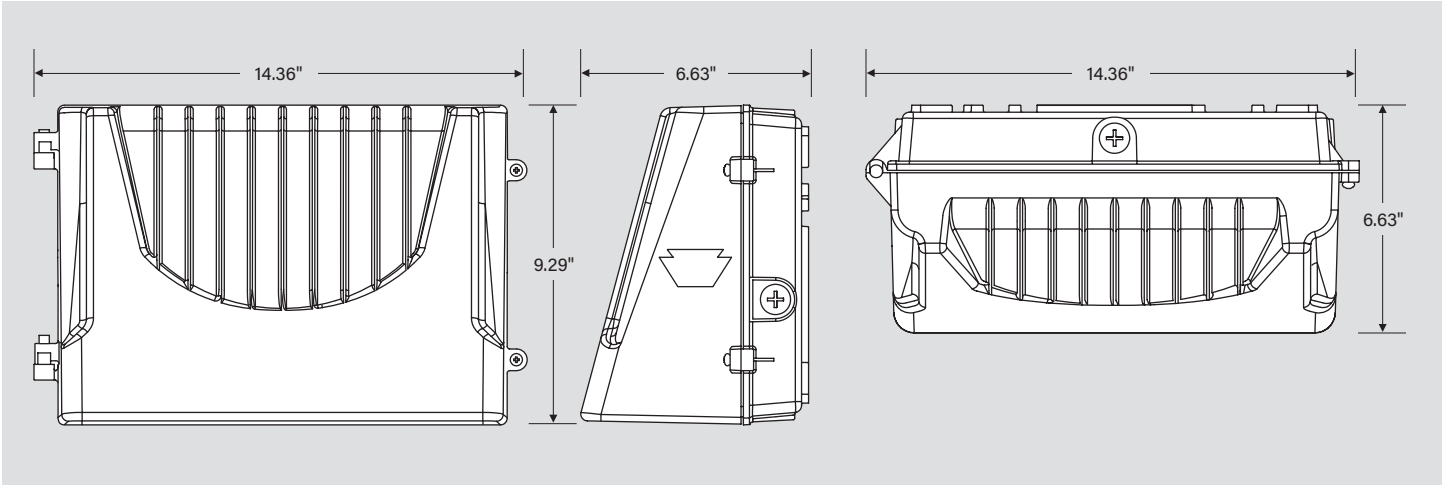

GENERAL SETUP INSTRUCTIONS

GENERAL WIRING DIAGRAM

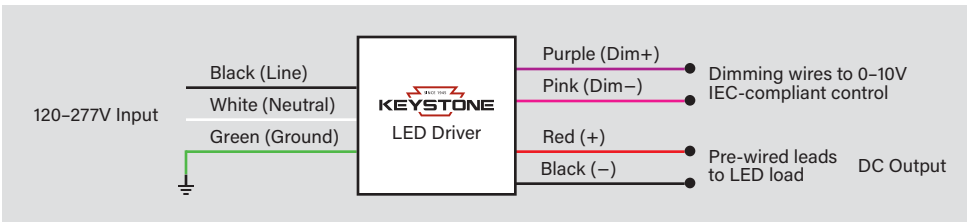

Caution: Before installing, make certain that AC power to the fixture is off.

Caution: The electrical rating of this product is 120-277V. Installer must confirm that there is 120-277V at the fixture before installation.



KT-WPLED40-M2-8XX-VDIM

ARCHITECTURAL FULL-CUTOFF LED WALL PACK

ACCESSORIES

SENSORS

Factory-Installable OR Field-Installable (field-installable purchased separately)

✓	SUFFIX*	CATALOG NUMBER	DESCRIPTION	UPC	EASY CODE
	/MW3	KTS-MW3-UV-KO-K1	Microwave Sensor Kit, Includes 120-277V input to 12V DC convertor & 12V input sensor head, IP65. Bi-Level Control with Adjustable Hold Time, Dim Level and Standby Time. Installs via standard 1/2in KO	843654134147	BKG-51
	/PS	KT-WPLED-PS-UV-KO	Dawn to Dusk Photocell for WallPack fixtures. Fits M1, M2, L1 housings. 120-277V Input. Install via standard 1/2in KO	843654129198	DLU-58



* For factory installation of accessory, add suffix to fixture part number (see ordering examples and instructions on last page of spec sheet).

CORD SETS

Factory-Installable OR Field-Installable (field-installable purchased separately)

✓	SUFFIX*	CATALOG NUMBER	DESCRIPTION	UPC	EASY CODE
	/515P6	KT-CS-515P-6-18/3	Cord set for high bay; 125V NEMA 5-15P; straight blade plug; 6' SJTOW cable; 18/3 wire	843654140124	UKH-26
	/L515P6	KT-CS-L515P-6-16/3	Cord set for high bays; 250V NEMA L5-15P; twist lock plug; 6' SJTOW cable; 16/3 wire	843654140186	POC-82

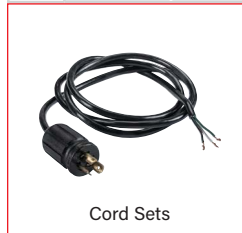

* For factory installation of accessory, add suffix to fixture part number (see ordering examples and instructions on last page of spec sheet).
Note: For cord sets not listed here, please contact your Keystone sales rep.

(Accessories continued on next page)



KT-WPLED40-M2-8XX-VDIM

ARCHITECTURAL FULL-CUTOFF LED WALL PACK

ACCESSORIES (continued)

EMERGENCY BACKUP

Factory-Installable OR Field-Installable (field-installable purchased separately)

✓	SUFFIX*	CATALOG NUMBER	DESCRIPTION	UPC	EASY CODE
	/EM12	KT-EMRG-LED-12C-1200	LED Emergency Back-Up, 12W Constant Wattage Design. Approx 1200 Lumens. 120-277V Input. Remote Compact Battery Pack. CEC T20 Compliant.	843654103112	OJQ-32
	-	KT-EMRG-LED2-TS-IP65	IP65 Rated Wet Location Test Switch for 5W and 12W CEC Compliant LED Emergency Packs	843654130019	MDB-29



12W, 1200 lumen Battery Backup
KT-EMRG-LED-12C-1200



Wet Location Test Switch
KT-EMRG-LED2-TS-IP65

* For factory installation of accessory, add suffix to fixture part number (see ordering examples and instructions on last page of spec sheet).
† Factory installation of emergency backup units will automatically include any relevant mounting bracket.

MOUNTS AND BRACKETS

Field-Installable / Field-Use ONLY (purchased separately)

✓	SUFFIX*	CATALOG NUMBER	DESCRIPTION	UPC	EASY CODE
	-	KT-WPLED-BP-M	Back Plate for Medium Size Wallpacks, Covers Legacy Style Large HID Housing Dimensions. Standard Bronze Color.	843654130613	CCJ-21



Back Plate
KT-WPLED-BP-M

* For factory installation of accessory, add suffix to fixture part number (see ordering examples and instructions on last page of spec sheet).
Note: This is needed with EM - will be added when factory installing EM

SURGE PROTECTORS

Factory-Installable OR Field-Installable (field-installable purchased separately)

✓	SUFFIX*	CATALOG NUMBER	DESCRIPTION	UPC	EASY CODE
	/10KV	KTSP-10KV-C	External Surge Protector, compact design. Parallel Wiring, 120-277V Input, Max Peak Protection (10KV, 10KA)	843654129204	BUU-26



External Surge Protector
KTSP-10KV-C

* For factory installation of accessory, add suffix to fixture part number (see ordering examples and instructions on last page of spec sheet).



KT-WPLED40-M2-8XX-VDIM

ARCHITECTURAL FULL-CUTOFF LED WALL PACK

ORDERING INFORMATION

CATALOG NUMBER	PACK QTY.	UPC	EASY CODE	DLC PRODUCT ID
KT-WPLED40-M2-840-VDIM	1	843654129051	EXI-18	P29LMVYC
KT-WPLED40-M2-850-VDIM	1	843654129068	GEK-93	PLGYPBOG

CATALOG NUMBER BREAKDOWN

KT-WPLED40-M2-8XX-VDIM

1	2	3	4	5	6	7	8	9	10
1 Keystone Technologies	2 Fixture Type	3 LED Lamp	4 Max Wattage	5 Size	6 Style	7 CRI	8 CCT	9 Dimming	10 Additional Options
	WP Wallpack			M Medium	2 Full-Cutoff	8 >80	40 4000K	VDIM 0-10V	
							50 5000K		

ORDERING EXAMPLES

FIXTURE WITH MULTIPLE FACTORY-INSTALLED ACCESSORIES*

KT-WPLED40-M2-8XX-VDIM /MW3/515P6/EM12

FIXTURE WITH SINGLE FACTORY-INSTALLED ACCESSORY

KT-WPLED40-M2-8XX-VDIM /MW3

FIXTURE WITH NO FACTORY-INSTALLED ACCESSORIES

KT-WPLED40-M2-8XX-VDIM

KEYSTONE FIXTURE

CATALOG NUMBER
KT-WPLED40-M2-8XX-VDIM

SENSORS

<input checked="" type="checkbox"/>	SUFFIX	CATALOG NUMBER
<input checked="" type="checkbox"/>	/MW3	KTS-MW3-UV-KO-K1

CORD SETS

<input checked="" type="checkbox"/>	SUFFIX	CATALOG NUMBER
<input checked="" type="checkbox"/>	/515P6	KT-CS-515P-6-18/3

EMERGENCY BACKUP

<input checked="" type="checkbox"/>	SUFFIX	CATALOG NUMBER
<input checked="" type="checkbox"/>	/EM12	KT-EMRG-LED-12C-1200

* When ordering more than one factory-installed accessory, use multiple suffixes as shown in the ordering examples above.
 Note: All accessories can also be ordered separately for field installation using just their regular Catalog Number, UPC, or Easy Code.