

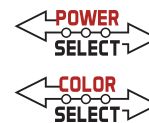

# XFIT



## KT-WPLED35PS-S3-8CSB-VDIM-W

### ADJUSTABLE WALL PACK

#### DESCRIPTION

0° - 90° Adjustable LED Wall Pack | Power Select | Color Select | 120-277V | White Housing

#### APPLICATION

Commercial wall mount applications for outdoor illumination (alleys, pathways, landscape lighting)



**10 YEAR**  
LIMITED WARRANTY



#### PRODUCT FEATURES

- Keystone Power Select technology (35/25/15W)
- Keystone Color Select technology (3000/4000/5000K)
- 0° - 90° field adjustable light positioning to illuminate areas missed by traditional forward throw wall packs
- Heavy duty, die cast aluminum housing with enhanced performance and reliability
- Built in dusk to dawn photocell behind translucent 3/4" threaded plug with antiyellowing agent
- Powered by Keystone 0-10V dimming LED drivers
- Ambient operating temperature: -40°C/-40°F - 50°C/122°F
- UL certified, IP65 rated
- THD: < 20%
- LED chip lifetime: L70 > 100,000 hrs @ 25°C/77°F ambient fixture temperature
- Meets FCC Part 15, Part B, Class A standards for conducted and radiated emissions

#### PRODUCT SPECIFICATIONS

Catalog Number	Wattage	CCT	Lumens	Efficacy	Dimming	CRI	Input Voltage	Photocell	Housing Color	Rated Life	Legacy Equivalent
KT-WPLED35PS-S3-8CSB-VDIM-W	35W	3000K	4375	125 lm/W	0-10V	>80	120-277V	Included	White	50,000 hrs	150W MH
		4000K	5075	145 lm/W							
		5000K	4725	135 lm/W							
	25W	3000K	3375	135 lm/W							
		4000K	3750	150 lm/W							
		5000K	3625	145 lm/W							
	15W	3000K	2178	145 lm/W							
		4000K	2325	155 lm/W							
		5000K	2250	150 lm/W							

#### PHYSICAL SPECIFICATIONS

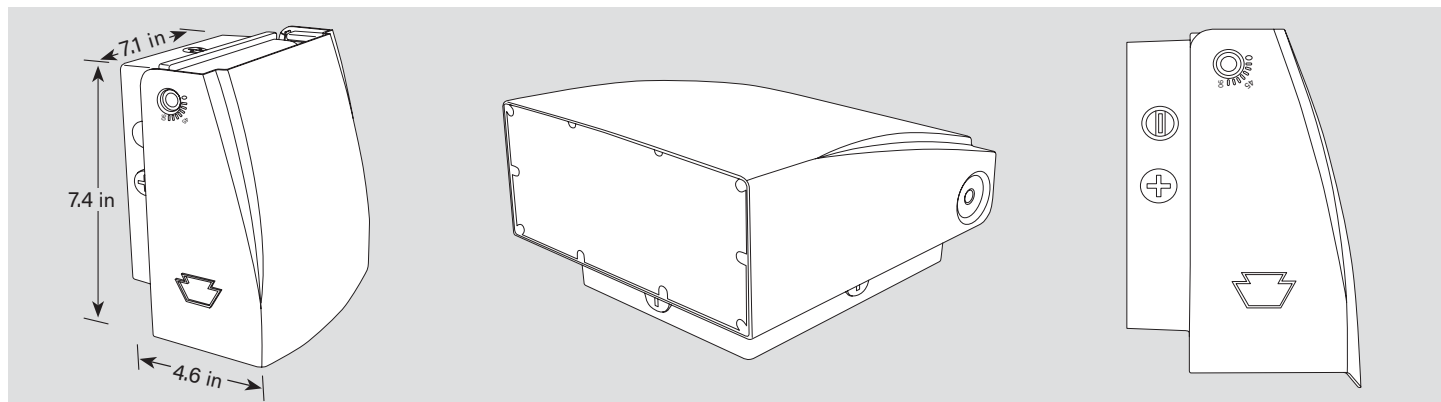

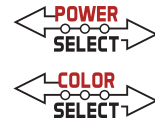

# KT-WPLED35PS-S3-8CSB-VDIM-W

## ADJUSTABLE WALL PACK

### GENERAL SETUP INSTRUCTIONS

#### GENERAL WIRING DIAGRAM

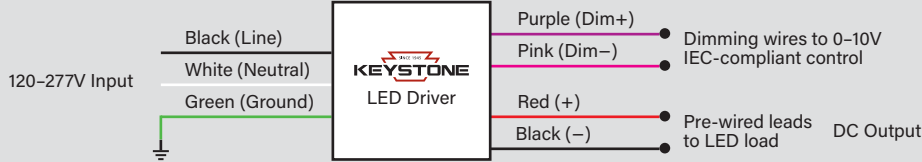

**Caution:** Before installing, make certain that AC power to the fixture is off.

**Caution:** The electrical rating of this product is 120-277V. Installer must confirm that there is 120-277V at the fixture before installation.

Note: \*In accordance with NEC-20 410.69 2022, all 0-10V negative wires have been updated from gray to pink. Please contact Keystone for details

#### ANGLE ADJUSTMENT INSTRUCTIONS

1. Loosen the screw on the side of the housing using an Allen wrench.
2. Adjust housing to desired setting, 0° - 90° in 15° intervals.
3. Tighten the screw on the side of the housing using the Allen wrench in Step 1.

#### PHOTOCELL AND CCT ADJUSTMENT

This fixture is equipped with a dusk to dawn photocell behind the translucent knockout (KO). Enable or disable the photocell by removing the cap and adjusting the dip switch to your desired setting. Fixture comes preset with photocell enabled. This fixture is also equipped with Keystone Color Select technology. The CCT dip switch is located in the same KO as the photocell. Remove the cap and adjust to your desired setting. This fixture comes preset to 5000K.

#### WATTAGE ADJUSTMENT

This fixture is equipped with Keystone Power Select technology. The adjustable knob is located in the driver compartment. See instructions below on how to access. Fixture comes preset to either 75W or 35W, depending on model ordered.

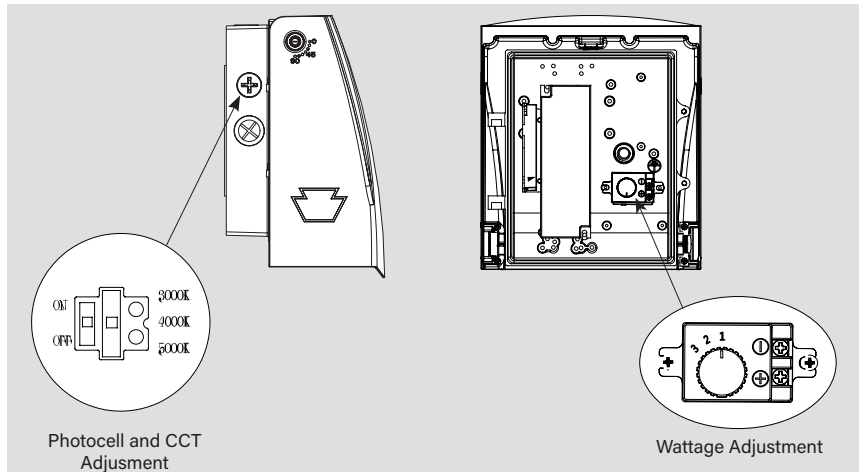

Note: Settings in drawing used for reference. Different models will show different settings.

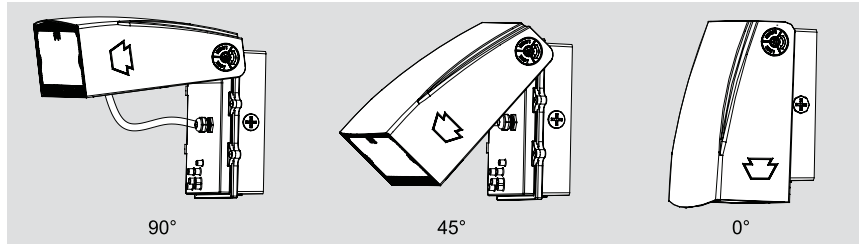

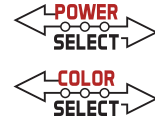

# KT-WPLED35PS-S3-8CSB-VDIM-W

## ADJUSTABLE WALL PACK

### PHOTOMETRICS

Full cutoff wall pack  
35W 5000K  
Building mounted 15'

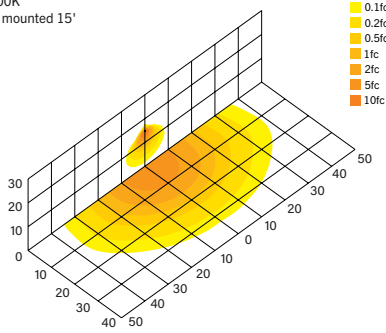

Full cutoff wall pack  
25W 5000K  
Building mounted 15'

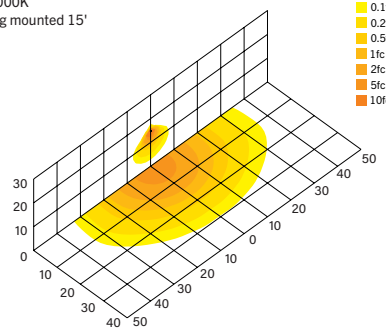

Full cutoff wall pack  
15W 5000K  
Building mounted 15'

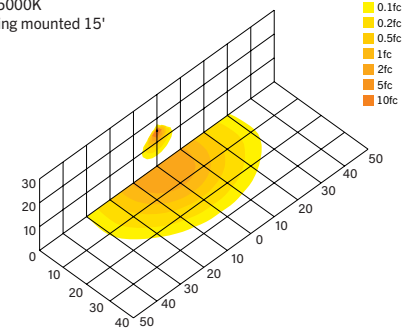

Luminous Intensity Distribution Curve

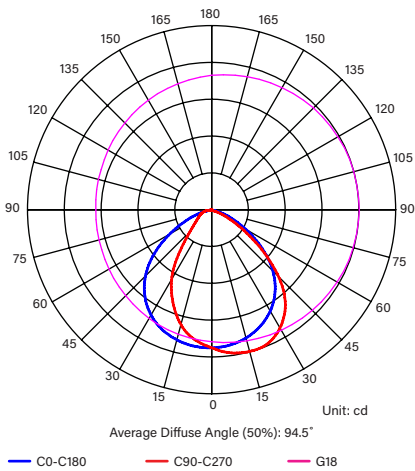

Isocandela (Rectangle)

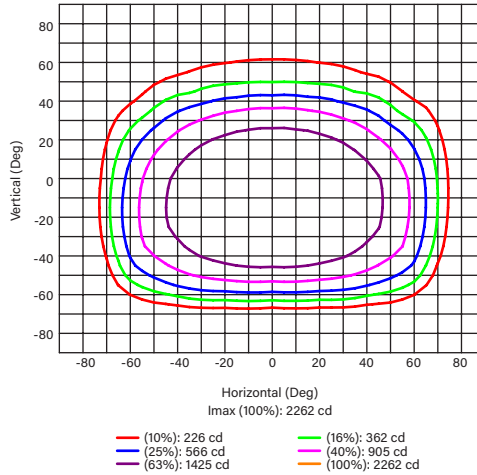

ZONE	LUMENS	% LAMP LUMENS
<b>FORWARD LIGHT</b>	<b>2938</b>	<b>60.3</b>
FL (0° - 30°)	904	18.6
FM (30° - 60°)	1674	34.4
FH (60° - 80°)	352	7.2
FVH (80° - 90°)	9	0.2
<b>BACK LIGHT</b>	<b>1886</b>	<b>38.7</b>
BL (0° - 30°)	768	15.8
BM (30° - 60°)	917	18.8
BH (60° - 80°)	175	3.6
BVH (80° - 90°)	23	0.5
<b>UP LIGHT</b>	<b>49</b>	<b>1.0</b>
UL (90° - 100°)	5	0.1
UH (100° - 180°)	44	0.9
<b>TRAPPED LIGHT</b>	<b>NA</b>	<b>NA</b>

BUG (Backlight, Uplight, Glare) Rating Base On TM-15-07	
Asymmetrical Luminaire Types (Type I, II, III, IV)	B2 U2 G1
Quadrilateral Symmetrical Luminaire Types (Type V, Area Light)	B2 U2 G1

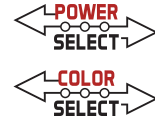

# KT-WPLED35PS-S3-8CSB-VDIM-W

## ADJUSTABLE WALL PACK

### ACCESSORIES

#### CORD SETS

**Factory-Installable OR Field-Installable** (field-installable purchased separately)

✓	SUFFIX*	CATALOG NUMBER	DESCRIPTION	UPC	EASY CODE
	/515P6	KT-CS-515P-6-18/3	Cord set for high bay; 125V NEMA 5-15P; straight blade plug; 6' SJTOW cable; 18/3 wire	843654140124	UKH-26
	/L515P6	KT-CS-L515P-6-16/3	Cord set for high bays; 250V NEMA L5-15P; twist lock plug; 6' SJTOW cable; 16/3 wire	843654140186	POC-82



Cord Sets

\* For factory installation of accessory, add suffix to fixture part number (see ordering examples and instructions on last page of spec sheet).  
**Note:** For cord sets not listed here, please contact your Keystone sales rep.

#### EMERGENCY BACKUP

**Field-Installable** (purchased separately)

✓	SUFFIX*	CATALOG NUMBER	DESCRIPTION	UPC	EASY CODE
	-	KT-EMRG-LED-12C-1200	LED Emergency Back-Up, 12W Constant Wattage Design. Approx 1200 Lumens. 120-277V Input. Remote Compact Battery Pack. CEC T20 Compliant.	843654103112	OJQ-32
	-	KT-EMRG-LED2-TS-IP65	IP65 Rated Wet Location Test Switch for 5W and 12W CEC Compliant LED Emergency Packs	843654130019	MDB-29



12W, 1200 lumen Battery Backup  
KT-EMRG-LED-12C-1200

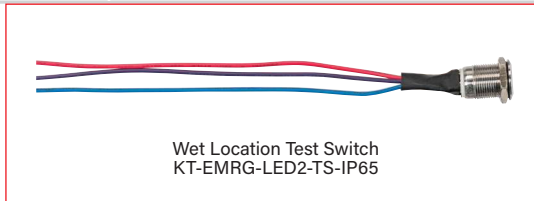

Wet Location Test Switch  
KT-EMRG-LED2-TS-IP65

#### SURGE PROTECTORS

**Factory-Installable OR Field-Installable** (field-installable purchased separately)

✓	SUFFIX*	CATALOG NUMBER	DESCRIPTION	UPC	EASY CODE
	/10KV	KTSP-10KV-C	External Surge Protector, compact design. Parallel Wiring, 120-277V Input, Max Peak Protection (10KV, 10KA)	843654129204	BUU-26



External Surge Protector  
KTSP-10KV-C

\* For factory installation of accessory, add suffix to fixture part number (see ordering examples and instructions on last page of spec sheet).

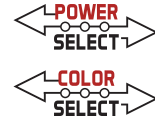

# KT-WPLED35PS-S3-8CSB-VDIM-W

## ADJUSTABLE WALL PACK

### ORDERING INFORMATION

CATALOG NUMBER	UPC	EASY CODE	DLC PRODUCT ID
KT-WPLED35PS-S3-8CSB-VDIM-W	843654141855	NXL-27	S-WN3FD9

### CATALOG NUMBER BREAKDOWN

# KT-WPLED35PS-S3-8CSB-VDIM-W

1	2	3	4	5	6	7	8	9	10	11	12
<b>1</b> Keystone Technologies	<b>2</b> Wall Pack	<b>3</b> LED	<b>4</b> Max Wattage	<b>5</b> Power Select	<b>6</b> Size	<b>7</b> Style	<b>8</b> CRI	<b>9</b> Color Select	<b>10</b> Color Select Designation	<b>11</b> 0-10V Dimming	<b>12</b> White Housing
						<b>6</b> Size			<b>8</b> CRI		
						<b>6</b> Size	S Small		<b>8</b> CRI	8 >80	
						<b>7</b> Style	3 Adjustable Full Cutoff		<b>10</b> Color Select Designation	B 3000/4000/5000K	

### ORDERING EXAMPLES

FIXTURE WITH TWO FACTORY-INSTALLED ACCESSORIES\*

**KT-WPLED35PS-S3-8CSB-VDIM-W /515P6/10KV**

FIXTURE WITH ONE FACTORY-INSTALLED ACCESSORY

**KT-WPLED35PS-S3-8CSB-VDIM-W /515P6**

FIXTURE WITH NO FACTORY-INSTALLED ACCESSORIES

**KT-WPLED35PS-S3-8CSB-VDIM-W**

#### KEYSTONE FIXTURE

CATALOG NUMBER
KT-WPLED35PS-S3-8CSB-VDIM-W

#### CORD SETS

✓ SUFFIX	CATALOG NUMBER
✓ /515P6	KT-CS-515P-6-18/3

#### SURGE PROTECTORS

✓ SUFFIX	CATALOG NUMBER
✓ /10KV	KTSP-10KV-C

\* When ordering more than one factory-installed accessory, use multiple suffixes as shown in the ordering examples above.  
 Note: All accessories can also be ordered separately for field installation using just their regular Catalog Number, UPC, or Easy Code.