

# KT-WPLED35PS-M4-8CSB-VDIM

## SLIM 35W LED WALL PACK

**DESCRIPTION**

Slim Non Cutoff LED Wall Pack | Power Select | Color Select | 120-277V Input | Medium Housing | Bronze Finish | Glass Lens

**APPLICATION**

Building mount for exterior illumination (perimeters, pathways, loading docks, and other general security lighting requirements)



**PRODUCT FEATURES**

- Keystone Power Select technology (35/25/15W)
- Keystone Color Select technology (3000/4000/5000K)
- Slim, low profile design that matches footprint and distribution of legacy HID wall packs. Optimized for one-for-one replacements
- Heavy duty die cast aluminum housing with (5) 1/2" threaded conduit hubs: (1) on back and (1) on all four sides
- Powered by Keystone 0-10V dimming LED drivers
- Built-in dusk-to-dawn photocell behind translucent 3/4" threaded plug with anti-yellowing agent
- Borosilicate glass lens diffuses light source and provides uniform distribution
- Covers footprint of mid-size HID wallpacks
- Ambient operating temperature: -40°C/-40°F to 50°C/122°F
- UL Certified for wet locations; IP65 rated
- Fixture impact rating IK06
- Power Factor: >0.95
- THD: <20%
- LED chip lifetime: L70 >100,000 hrs @ 25°C/77°F ambient fixture temperature
- Meets FCC Part 15, Part B, Class A standards for conducted and radiated emissions
- TAA options available, see Ordering Information below for details

**PRODUCT SPECIFICATIONS**

Catalog Number	Wattage	CCT	Lumens	Efficacy	Input Voltage	Dimming	CRI	Photocell	Housing Color	Legacy Equivalent
KT-WPLED35PS-M4-8CSB-VDIM	35W	3000K	4550	130 lm/W	120-277V	0-10V	>80	Included	Bronze	175W MH
		4000K	4655	133 lm/W						
		5000K	4620	132 lm/W						
	25W	3000K	3400	136 lm/W						
		4000K	3525	141 lm/W						
		5000K	3475	139 lm/W						
	15W	3000K	2100	140 lm/W						
		4000K	2160	144 lm/W						
		5000K	2160	144 lm/W						

\* Color Uniformity: CCT (Correlated Color Temperature) range as per guidelines outlined in ANSI C78.377-2017

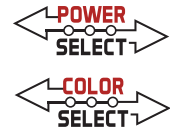

# KT-WPLED35PS-M4-8CSB-VDIM

## SLIM 35W LED WALL PACK

### PHYSICAL SPECIFICATIONS

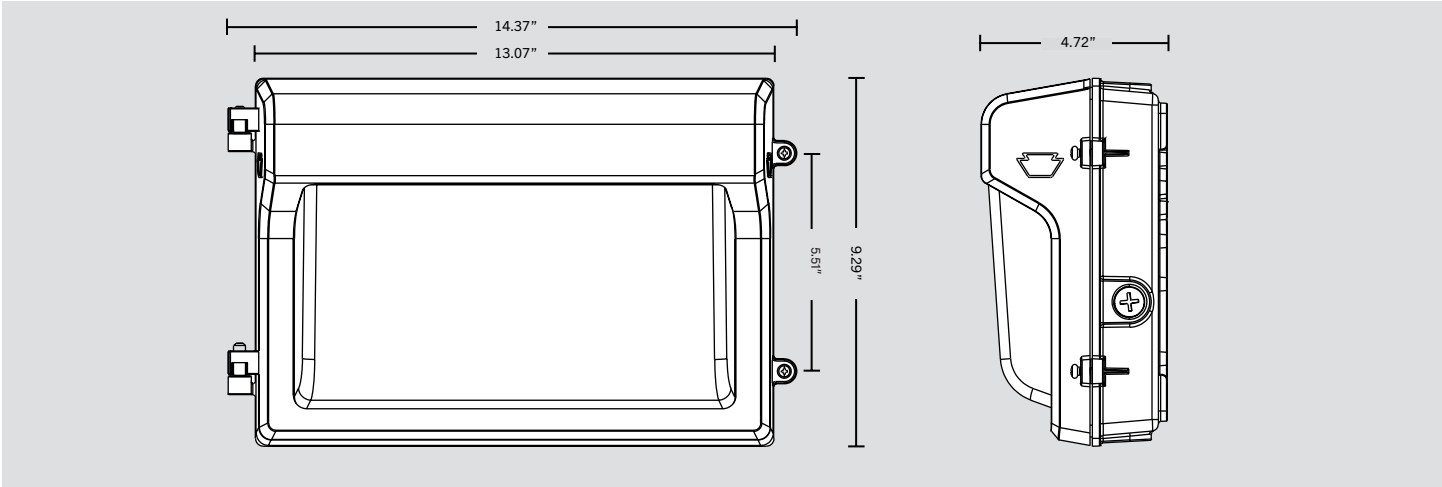

### GENERAL SETUP INSTRUCTIONS

#### GENERAL WIRING DIAGRAM

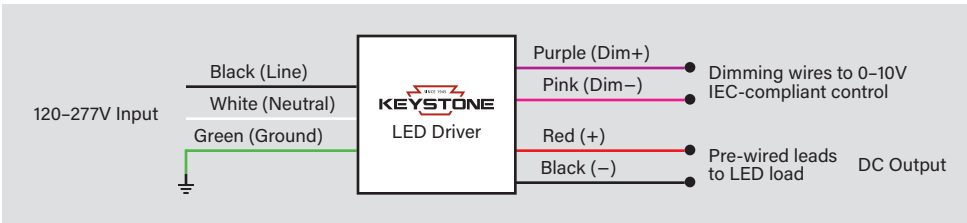

**Caution:** Before installing, make certain that AC power to the fixture is off.

**Caution:** The electrical rating of this product is 120-277V. Installer must confirm that there is 120-277V at the fixture before installation.

#### PHOTOCELL ENABLE / DISABLE

This fixture is equipped with a dusk-to-dawn photocell behind the translucent knock-out (KO) cover. Adjust the dip switch to enable (ON) or disable (OFF) the photocell function (see illustrations to the right). Fixture comes pre-set with photocell enabled unless otherwise noted.

#### COLOR SELECT (CCT) ADJUSTMENT

This fixture is equipped with Color Select technology. There is an adjustable dip switch behind the translucent knock-out (KO) cover to change CCT between 5000K, 4000K, and 3000K (see illustrations to the right). Fixture comes pre-set at 5000K unless otherwise noted.

#### POWER SELECT (WATTAGE) ADJUSTMENT

The Power Select dial for this fixture is located inside of the housing. To access the dial, open the fixture face (see below instructions for reference). This wall pack is selectable between 3 wattage options, and is pre-set to the highest option. Please see chart below for details.

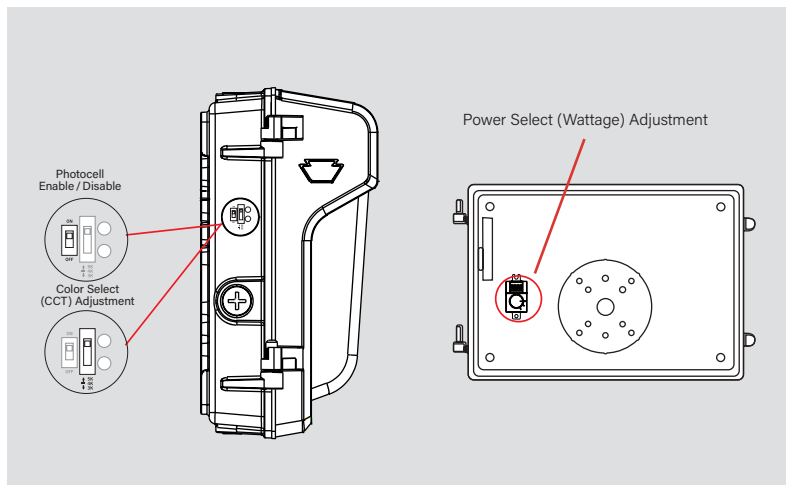

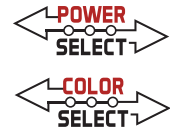

# KT-WPLED35PS-M4-8CSB-VDIM

## SLIM 35W LED WALL PACK

### PHOTOMETRIC SPECIFICATIONS

#### ISOCANDELA PLOT

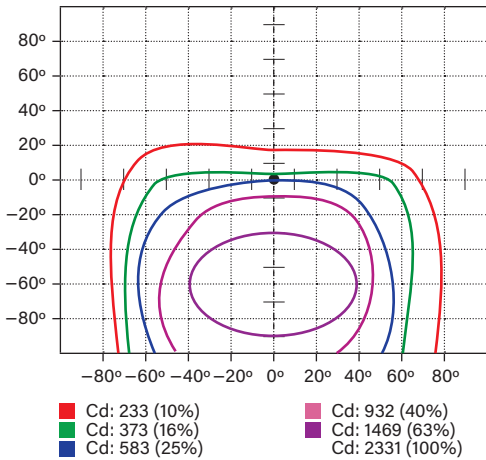

#### LUMINOUS INTENSITY DISTRIBUTION

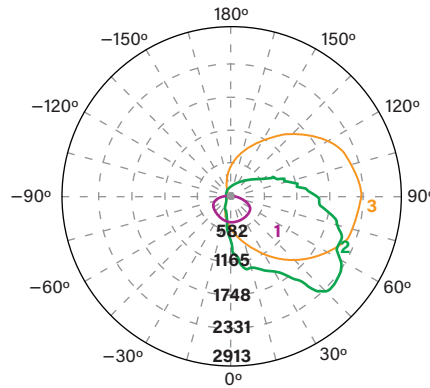

Average diffuse angle (50%): **121.6°**

- 1 Violet C0 - C180
- 2 Green C90 - C270
- 3 Orange G48

Unit: cd

#### FLUX DISTRIBUTION

Zone	Lumens	% Luminaire
<b>Forward Light</b>	3,645 lm	81.6%
0°-30°	411 lm	9.2%
30°-60°	1,584 lm	35.4%
60°-80°	1,220 lm	27.3%
80°-90°	429 lm	9.6%
<b>Back Light</b>	216 lm	4.8%
0°-30°	78 lm	1.7%
30°-60°	84 lm	1.9%
60°-80°	43 lm	1.0%
80°-90°	11 lm	0.2%
<b>Up Light</b>	609 lm	13.6%
90°-100°	290 lm	6.5%
100°-180°	319 lm	7.1%

#### BUG\* Rating

##### Asymmetrical Luminaire Types

Type I, II, III, IV      B0 U5 G3

##### Quadrilateral Symmetrical Luminaire Types

Type V, Area Light      B0 U5 G3

\* Backlight, Uplight, Glare

#### MOUNTING

Side view

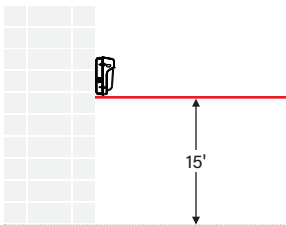

#### LIGHT DISTRIBUTION PATTERN

Isometric view from above; Luminaire mounted at 15'

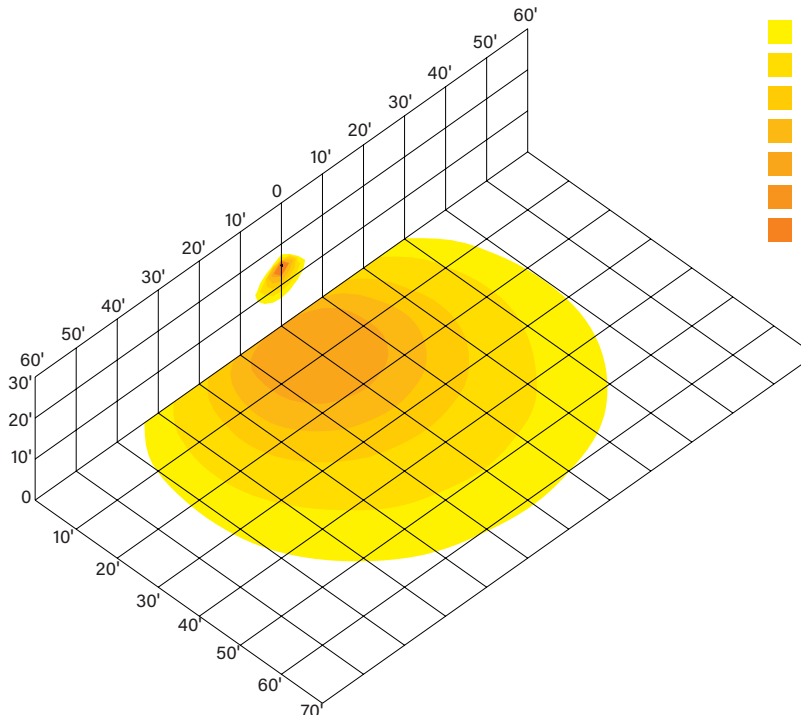

- 0.1fc
- 0.2fc
- 0.5fc
- 1fc
- 2fc
- 5fc
- 10fc

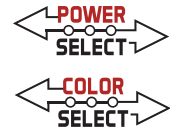

# KT-WPLED35PS-M4-8CSB-VDIM

## SLIM 35W LED WALL PACK

### ACCESSORIES

#### SENSORS

**Factory-Installable OR Field-Installable** (field-installable purchased separately)

✓	SUFFIX*	CATALOG NUMBER	DESCRIPTION	UPC	EASY CODE
	/MW3	KTS-MW3-UV-KO-K1	Microwave Sensor Kit, Includes 120-277V input to 12V DC convertor & 12V input sensor head, IP65. Bi-Level Control with Adjustable Hold Time, Dim Level and Standby Time. Installs via standard 1/2in KO	843654134147	BKG-51



\* For factory installation of accessory, add suffix to fixture part number (see ordering examples and instructions on last page of spec sheet).

#### CORD SETS

**Factory-Installable OR Field-Installable** (field-installable purchased separately)

✓	SUFFIX*	CATALOG NUMBER	DESCRIPTION	UPC	EASY CODE
	/515P6	KT-CS-515P-6-18/3	Cord set for high bay; 125V NEMA 5-15P; straight blade plug; 6' SJTOW cable; 18/3 wire	843654140124	UKH-26
	/L515P6	KT-CS-L515P-6-16/3	Cord set for high bays; 250V NEMA L5-15P; twist lock plug; 6' SJTOW cable; 16/3 wire	843654140186	POC-82



\* For factory installation of accessory, add suffix to fixture part number (see ordering examples and instructions on last page of spec sheet).  
**Note:** For cord sets not listed here, please contact your Keystone sales rep.

#### MOUNTS AND BRACKETS

**Field-Installable / Field-Use ONLY** (purchased separately)

✓	SUFFIX*	CATALOG NUMBER	DESCRIPTION	UPC	EASY CODE
	-	KT-WPLED-BP-M	Back Plate for Medium Size Wallpacks, Covers Legacy Style Large HID Housing Dimensions. Standard Bronze Color.	843654130613	CCJ-21

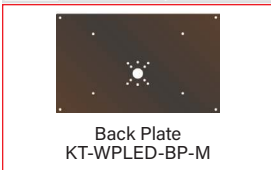

\* For factory installation of accessory, add suffix to fixture part number (see ordering examples and instructions on last page of spec sheet).

\* For factory installation of accessory, add suffix to fixture part number (see ordering examples and instructions on last page of spec sheet).

(Accessories continued on next page)

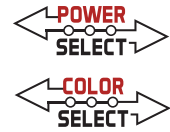

# KT-WPLED35PS-M4-8CSB-VDIM

## SLIM 35W LED WALL PACK

**ACCESSORIES** (continued)

**SURGE PROTECTORS**

Factory-Installable OR Field-Installable (field-installable purchased separately)

✓	SUFFIX*	CATALOG NUMBER	DESCRIPTION	UPC	EASY CODE
	/10KV	KTSP-10KV-C	External Surge Protector, compact design. Parallel Wiring, 120-277V Input, Max Peak Protection (10KV, 10KA)	843654129204	BUU-26



\* For factory installation of accessory, add suffix to fixture part number (see ordering examples and instructions on last page of spec sheet).

**ORDERING INFORMATION**

CATALOG NUMBER	PACK QTY.	UPC	EASY CODE	DLC PRODUCT ID
KT-WPLED35PS-M4-8CSB-VDIM	1	843654155524	RKA-78	TBD
KT-WPLED35PS-M4-8CSB-VDIM /TAA	1	843654158730	BQC-61	

**CATALOG NUMBER BREAKDOWN**

# KT-WPLED35PS-M4-8CSB-VDIM

- 1
- 2
- 3
- 4
- 5
- 6
- 7
- 8
- 9
- 10
- 11
- 12

**1 Keystone Technologies**

**2 Fixture Type**

**3 LED Lamp**

**4 Max Wattage**

**5 Power Select**

**6 Size**

**7 Style**

**8 Color Select**

**9 Color Select Designation**

**10 Dimming**

**11 Accessories (see below for details)**

**12 TAA Compliant**

**2 Fixture Type**

WP	Wall Pack
----	-----------

**6 Size**

M	Medium
---	--------

**7 Style**

4	Slim, Low Profile
---	-------------------

**8 CRI**

8	>80
---	-----

**9 Color Select Designation**

B	3000/4000/5000K
---	-----------------

**10 Dimming**

VDIM	0-10V
------	-------

**12 TAA Compliant**

/TAA	Made in Mexico
------	----------------

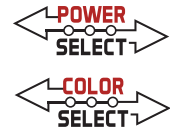

# KT-WPLED35PS-M4-8CSB-VDIM

SLIM 35W LED WALL PACK

### ORDERING EXAMPLES

FIXTURE WITH MULTIPLE FACTORY-INSTALLED ACCESSORIES\*

**KT-WPLED35PS-M4-8CSB-VDIM /MW3/515P6**



FIXTURE WITH SINGLE FACTORY-INSTALLED ACCESSORY

**KT-WPLED35PS-M4-8CSB-VDIM /MW3**

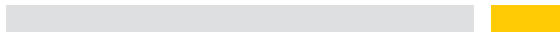

FIXTURE WITH NO FACTORY-INSTALLED ACCESSORIES

**KT-WPLED35PS-M4-8CSB-VDIM**



\* When ordering more than one factory-installed accessory, use multiple suffixes as shown in the ordering examples above.  
**Note:** All accessories can also be ordered separately for field installation using just their regular Catalog Number, UPC, or Easy Code.

KEYSTONE FIXTURE	
CATALOG NUMBER	
KT-WPLED35-M1-8CSB-VDIM	

SENSORS		
	SUFFIX	CATALOG NUMBER
<input checked="" type="checkbox"/>	/MW3	KTS-MW3-UV-KO-K1

CORD SETS		
	SUFFIX	CATALOG NUMBER
<input checked="" type="checkbox"/>	/515P6	KT-CS-515P-6-18/3