



XFIT



KT-WPLED20-S1-8CSB-VDIM

SMALL NON-CUTOFF LED WALL PACK

DESCRIPTION

Small 20W Non-Cutoff LED Wall Pack | 120-277V Input |
3000-5000K | Low Profile Housing | Bronze Finish | Impact Resistant Lens

APPLICATION

Building mount for exterior illumination (entryways, pathways, stairwells, security, and other general site lighting requirements)



10 YEAR
LIMITED WARRANTY



PRODUCT FEATURES

- Keystone Color Select technology (3000/4000/5000K)
- Small non-cutoff design can be mounted virtually anywhere, offering uniform vertical and horizontal distribution pattern for general safety and security illumination needs
- Heavy duty die cast aluminum housing with (3) 1/2" threaded conduit hubs: (1) on back and (1) on each side
- Powered by Keystone 0-10V dimming LED drivers, dimmable to 10%
- Built-in dusk-to-dawn photocell behind translucent 1/2" threaded plug with anti-yellowing agent
- ADA Compliant with low-profile housing less than 4" deep
- Impact-resistant and highly diffused polycarbonate lens with anti-yellowing agent offers reduced glare for low mounting height applications
- Ambient operating temperature: -40°C/-40°F to 50°C/122°F
- UL Certified for wet locations; IP65 rated
- Fixture impact rating IK07
- Power Factor: >0.95
- THD: <20%
- LED chip lifetime: L70 >100,000 hrs @ 25°C/77°F ambient fixture temp
- Meets FCC Part 15, Part B, Class A standards for conducted and radiated emissions
- TAA options available, see Ordering Information below for details

PRODUCT SPECIFICATIONS

Catalog Number	Wattage	Lumens	Lumens Below 90°	Dimming	CCT*	Efficacy	CRI	Housing Color	Input Voltage	Rated Life	Legacy Equivalent
KT-WPLED20-S1-8CSB-VDIM	20W	2600	2340	0-10V	3000K	130 lm/W	>80	Bronze	120-277V	50,000 hrs	50-70W MH
		2700	2430		4000K	135 lm/W					
		2500	2330		5000K	125 lm/W					

* Color Uniformity: CCT (Correlated Color Temperature) range as per guidelines outlined in ANSI C78.377-2017

KT-WPLED20-S1-8CSB-VDIM

SMALL NON-CUTOFF LED WALL PACK

PHOTOMETRIC SPECIFICATIONS

ISOCANDELA PLOT

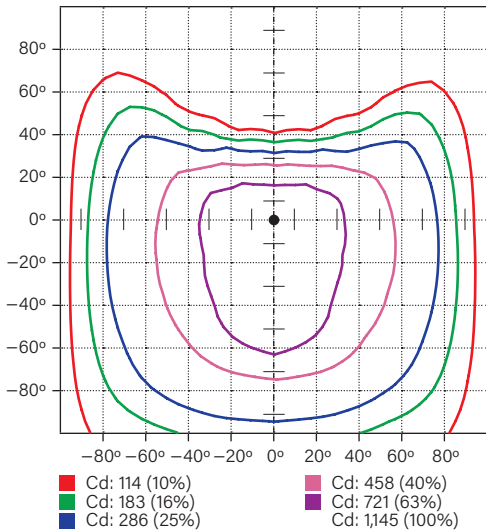

LUMINOUS INTENSITY DISTRIBUTION

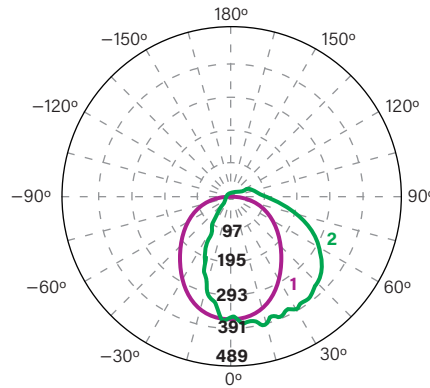

Average diffuse angle (50%): **100°**

1 Violet C0 - C180
2 Green C90 - C270
Unit: cd

FLUX DISTRIBUTION

Zone	Lumens	% Luminaire
Forward Light	1,653 lm	64.0%
0°-30°	379 lm	14.7%
30°-60°	758 lm	29.4%
60°-80°	400 lm	15.5%
80°-90°	116 lm	4.5%
Back Light	667 lm	25.8%
0°-30°	264 lm	10.2%
30°-60°	283 lm	11.0%
60°-80°	97 lm	3.8%
80°-90°	23 lm	0.9%
Up Light	261 lm	10.1%
90°-100°	92 lm	3.5%
100°-180°	170 lm	6.6%

BUG* Rating

Asymmetrical Luminaire Types	
Type I, II, III, IV	B1 U3 G1
Quadrilateral Symmetrical Luminaire Types	
Type V, Area Light	B1 U3 G1

* Backlight, Uplight, Glare

MOUNTING

Side view

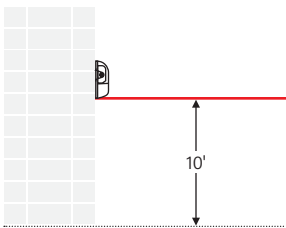

LIGHT DISTRIBUTION PATTERN

Isometric view from above; Luminaire mounted at 10'

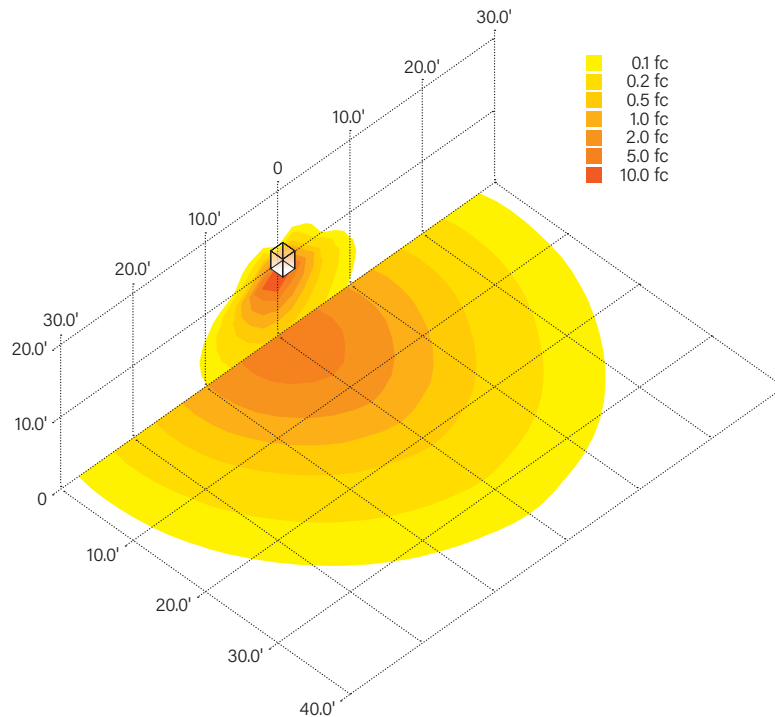



KT-WPLED20-S1-8CSB-VDIM

SMALL NON-CUTOFF LED WALL PACK

PHYSICAL SPECIFICATIONS

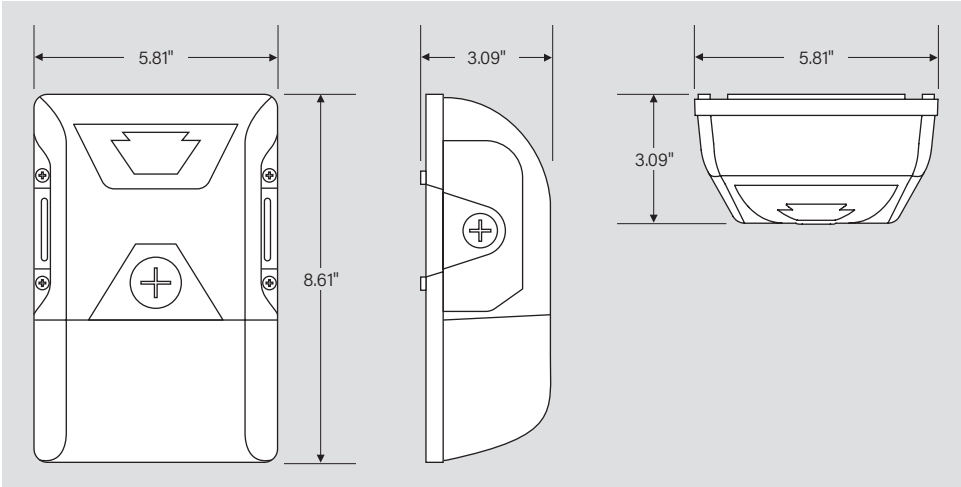

GENERAL SETUP INSTRUCTIONS

GENERAL WIRING DIAGRAM

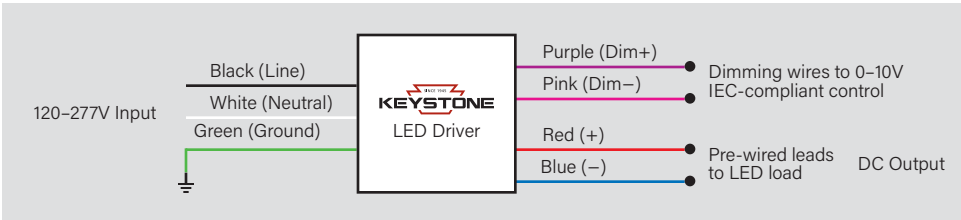

Caution: Before installing, make certain that AC power to the fixture is off.

Caution: The electrical rating of this product is 120-277V. Installer must confirm that there is 120-277V at the fixture before installation.

PHOTOCELL ENABLE / DISABLE

This fixture is equipped with a dusk-to-dawn photocell behind the translucent knock-out (KO) cover. Adjust the dip switch to enable (ON) or disable (OFF) the photocell function (see illustrations to the right). Fixture comes preset with photocell enabled unless otherwise noted.

COLOR SELECT (CCT) ADJUSTMENT

Certain fixture models are equipped with Color Select technology. There is an adjustable dip switch behind the translucent knock-out (KO) cover to change CCT between 5000K, 4000K, and 3000K (see illustrations to the right). Fixture comes preset at 5000K unless otherwise noted.

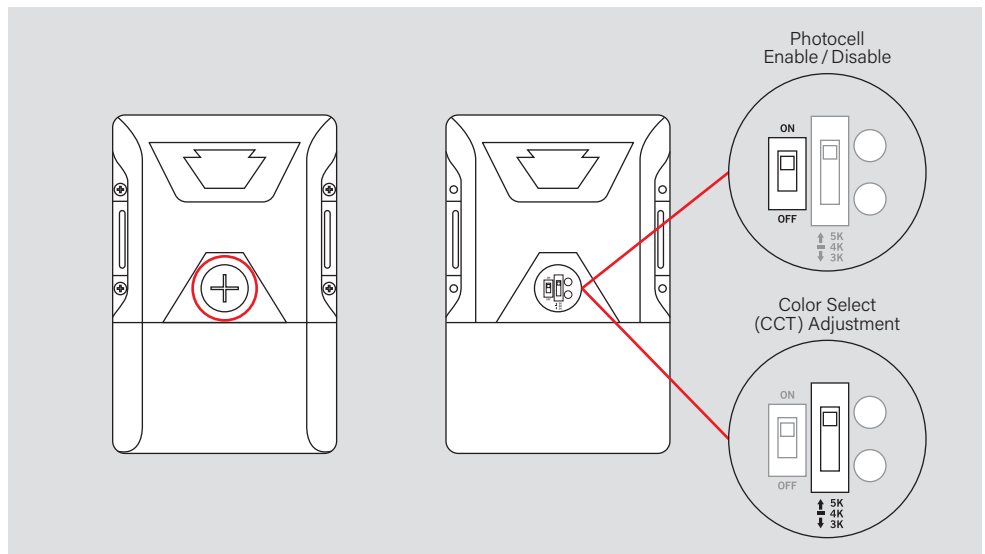



KT-WPLED20-S1-8CSB-VDIM

SMALL NON-CUTOFF LED WALL PACK

ACCESSORIES

CORD SETS

Factory-Installable OR Field-Installable (field-installable purchased separately)

✓	SUFFIX*	CATALOG NUMBER	DESCRIPTION	UPC	EASY CODE
	/515P6	KT-CS-515P-6-18/3	Cord set for high bay; 125V NEMA 5-15P; straight blade plug; 6' SJTOW cable; 18/3 wire	843654140124	UKH-26
	/L515P6	KT-CS-L515P-6-16/3	Cord set for high bays; 250V NEMA L5-15P; twist lock plug; 6' SJTOW cable; 16/3 wire	843654140186	POC-82

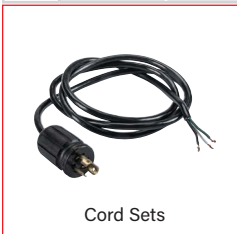

** For factory installation of accessory, add suffix to fixture part number (see ordering examples and instructions on last page of spec sheet).
Note: For cord sets not listed here, please contact your Keystone sales rep.*

SURGE PROTECTORS

Field-Installable / Field-Use ONLY (purchased separately)

✓	CATALOG NUMBER	DESCRIPTION	UPC	EASY CODE
	KTSP-10KV-C	External Surge Protector, compact design. Parallel Wiring, 120-277V Input, Max Peak Protection (10KV, 10KA)	843654129204	BUU-26

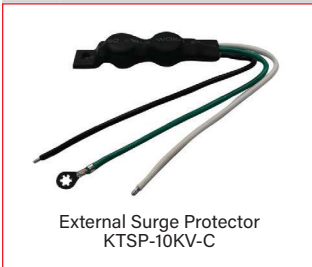

** For factory installation of accessory, add suffix to fixture part number (see ordering examples and instructions on last page of spec sheet).*



KT-WPLED20-S1-8CSB-VDIM

SMALL NON-CUTOFF LED WALL PACK

ORDERING INFORMATION

CATALOG NUMBER	PACK QTY.	UPC	EASY CODE	DLC PRODUCT ID
KT-WPLED20-S1-8CSB-VDIM	1	843654129112	XWA-37	PI7SCMGD
KT-WPLED20-S1-8CSB-VDIM /TAA	1	843654158792	KWP-53	

CATALOG NUMBER BREAKDOWN

KT-WPLED20-S1-8CSB-VDIM

1	2	3	4	5	6	7	8	9	10	11
1 Keystone Technologies	2 Fixture Type	3 LED Lamp	4 Max Wattage	5 Size	6 Style	7 CRI	8 Color Select	9 Color Select Designation	10 Dimming	11 TAA Compliant
	WP Wallpack			S Small	1 Non-Cutoff	8 >80	B 3000/4000/5000K		VDIM 0-10V	/TAA Made in Mexico

ORDERING EXAMPLES

FIXTURE WITH SINGLE FACTORY-INSTALLED ACCESSORY

KT-WPLED20-S1-8CSB-VDIM /515P6

FIXTURE WITH NO FACTORY-INSTALLED ACCESSORIES

KT-WPLED20-S1-8CSB-VDIM

KEYSTONE FIXTURE

CATALOG NUMBER
KT-WPLED20-S1-8CSB-VDIM

CORD SETS

SUFFIX	CATALOG NUMBER
✓ /515P6	KT-CS-515P-6-18/3

Note: All accessories can also be ordered separately for field installation using just their regular Catalog Number, UPC, or Easy Code.