

# KT-RHLED400PSHV-18C-8CSD-VDIM-P

## ROUND LED HIGH BAY FIXTURE

### DESCRIPTION

Round LED High Bay Fixture | Wet Location Rated | High Temp Rated

### APPLICATION

Used for commercial and industrial High Bay lighting applications



**10 YEAR**  
LIMITED WARRANTY



### PRODUCT FEATURES

- Available with Keystone's SmartLoop Bluetooth mesh wireless system, with features such as high-end trim, grouping, occupancy/vacancy sensing, and scheduling
- High Power Round High Bay, optimized for 40'+ mounting heights and related higher ambient temperatures
- Design features a large spacer between LED driver and the diecast heat sink to optimize thermal performance
- Features Keystone Power Select technology. Adjust power between 400/320/240W, changing lumen output to set high end trim.
- Features Keystone Color Select technology. Adjust CCT between 4000/5000K
- Designed with Keystone's SmartPort receptacle for adding sensors and controls.
- Powered by Keystone 0-10V dimming LED driver
- J-Hook mounting accessory included
- 6' cord for input and dimming wires
- Powder-coated aluminum housing
- Ribbed polycarbonate lens reduces glare
- Low optical flicker
- Built-in 6kV surge protection
- LED lifetime: L70 >100,000 hours @ 25°C
- Ambient operating temperature: -40°C/-40°F to 60°C/140°F
- IP65 rated, wet location
- TAA options available, see Ordering Information below for details

### PERFORMANCE SPECIFICATIONS

Catalog Number	Nominal Size	Selectable Wattage	Selectable CCT	Lumens	Efficacy	Input Voltage	Dimmable	CRI	Housing Color
KT-RHLED400PSHV-18C-8CSD-VDIM-P	18"	400W	4000K	59200	148 lm/W	277-480V	0-10V	> 80	Black
			5000K	61200	153 lm/W				
		320W	4000K	50550	158 lm/W				
			5000K	51200	160 lm/W				
		240W	4000K	39850	166 lm/W				
			5000K	40320	168 lm/W				

Note: Preset to highest lumen output (400W / 5000K)

Note: Color uniformity: CCT (Correlated Color Temperature) range as per guidelines outlined in ANSI C78.377-2017

### PHOTOMETRIC SPECIFICATIONS

#### ISOCANDELA PLOT

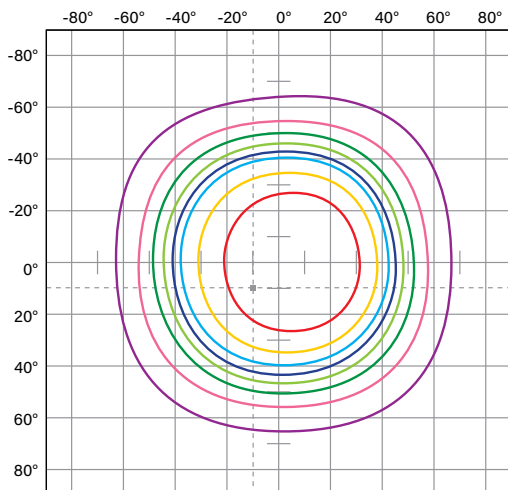

- Cd: 27899, 90%
- Cd: 23249, 75%
- Cd: 18599, 60%
- Cd: 15500, 50%
- Cd: 12400, 40%
- Cd: 9300, 30%
- Cd: 6200, 20%
- Cd: 3100, 10%
- Point of Max
- Cd: 31007.8

#### POLAR CANDELA DISTRIBUTION

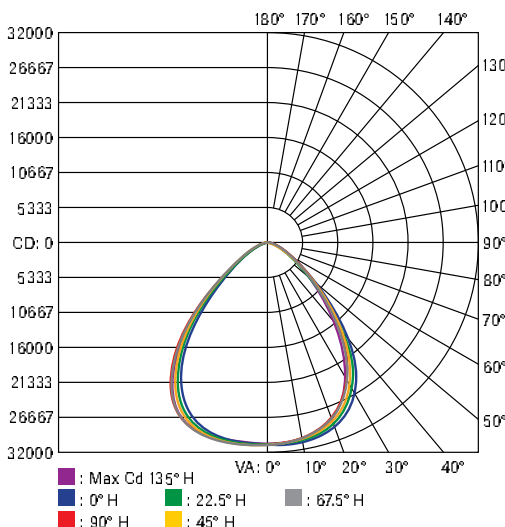

#### ZONAL LUMEN SUMMARY

Zone	Lumens	% Luminaire
0-30	245671	40.7%
0-40	389076	64.4%
0-60	55695.5	92.2%
60-90	4581.5	7.6%
70-100	1530.6	2.5%
90-120	21.5	0%
0-90	60277.0	99.8%
90-180	136.2	0.2%
0-180	60413.2	100%

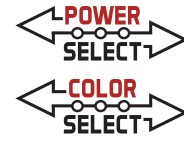

# KT-RHLED400PSHV-18C-8CSD-VDIM-P

## ROUND LED HIGH BAY FIXTURE

### PHYSICAL SPECIFICATIONS

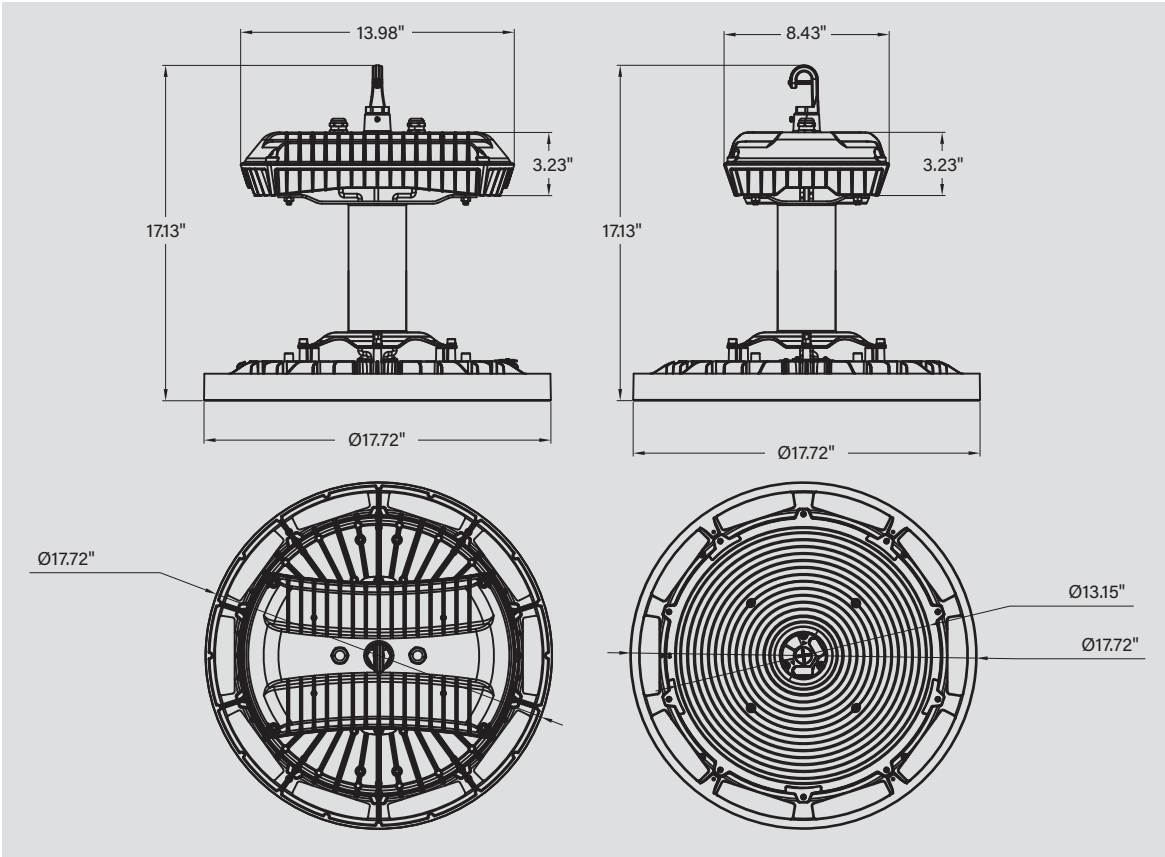

### POWER SELECTION AND CCT SELECTION CAPABILITY

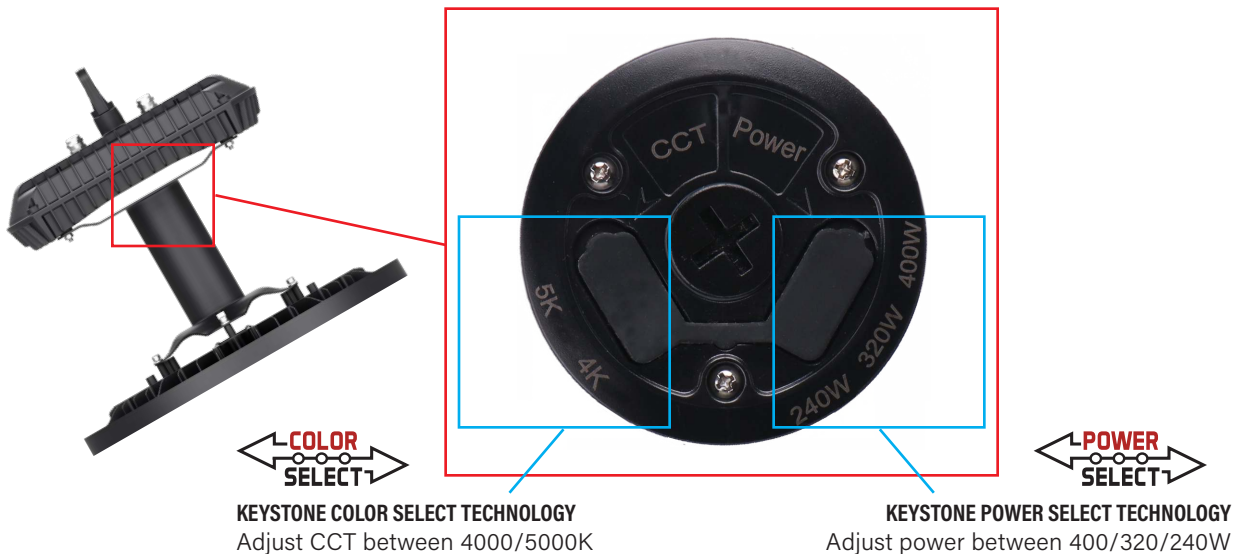

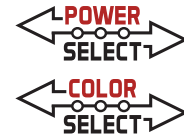

# KT-RHLED400PSHV-18C-8CSD-VDIM-P

## ROUND LED HIGH BAY FIXTURE

### QUICK-INSTALL

1. Ensure power is off to the fixture.
2. Remove 1/2" knock-out (KO) plug.
3. Screw in sensor head. (see illustrations)
4. Re-connect power when ready.
5. Program desired settings as needed with Keystone Remote Control.

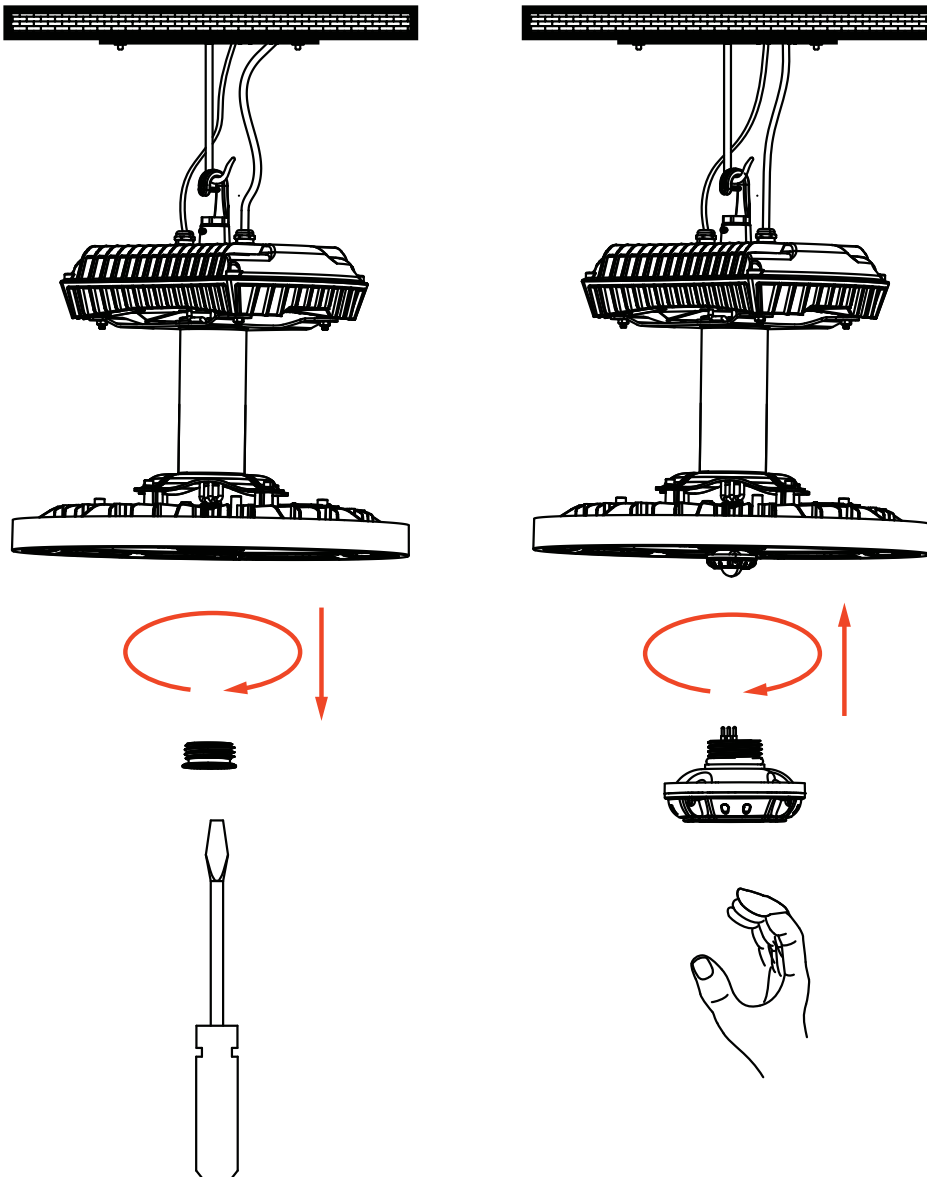

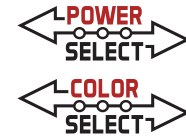

# KT-RHLED400PSHV-18C-8CSD-VDIM-P

## ROUND LED HIGH BAY FIXTURE

**ACCESSORIES**

**SENSORS AND CONTROLLER**

Factory-Installable OR Field-Installable (field-installable purchased separately)

✓	SUFFIX*	CATALOG NUMBER	DESCRIPTION	UPC	EASY CODE
	/FC3**	KTSL-FC3-12V-PKO-PIR	Smart Loop Bluetooth mesh screw-in PIR occupancy sensor with built-in fixture controller. No wiring required.	843654138862	OCW-60
	/FC4	KTSL-FC4-12V-PKO	Bluetooth mesh wireless screw-in low voltage fixture controller for SmartLoop system; 12V; 0-10V dimming	843654149066	RUN-10
	/PIR3	KTS-PIR3-12V-PKO /G2	Screw-in PIR motion sensor with daylight detection; Adjustable settings via remote control commissioning	843654146447	GLF-99
	/MW3	KTS-MW3-12V-PKO	Screw-in microwave sensor for round high bays; Preset for 10 min hold time, ∞ standby time at 50% dim, daylight disabled	843654135212	TRM-32



\* For factory installation of accessory, add suffix to fixture part number (see ordering examples and instructions on last page of spec sheet).  
 \*\*When installing on Keystone highbay lights and an IP tight connection is desired, use the xxxx gasket provided with the sensor to ensure proper electrical connection and water tight seal. Hand tighten only.

**Field-Installable / Field-Use ONLY (purchased separately)**

CATALOG NUMBER	DESCRIPTION	UPC	EASY CODE
KTS-MW3-REMOTECONTROL	Remote control for KTS-MW3-12V-PKO /A or /B and KTS-PIR3-12V-PKO /G2 sensors. Used to set and adjust all sensor settings	843654132020	XSR-61



(Accessories continued on next page)









**KT-RHLED400PSHV-18C-8CSD-VDIM-P**  
ROUND LED HIGH BAY FIXTURE

**ACCESSORIES (continued)**

**MOUNTS AND BRACKETS**

Field-Installable / Field-Use ONLY (purchased separately)

CATALOG NUMBER	DESCRIPTION	UPC	EASY CODE
KT-RHLED-SM-3-KIT /G2	Surface mount kit for round highbay fixtures; Fits 400W round highbay fixture; Includes mounting hardware	843654151755	JGH-39
KT-RHLED-AR90-3-KIT /G2	Aluminum reflector kit for 400W KT-RHLED fixtures; 90-degree beam angle; Includes dome and hardware	843654151748	MIV-43
KT-RHLED-CL90-3-KIT /G2	Clear polycarbonate reflector for 400W round highbay fixtures; 90-degree beam angle; Includes dome, bottom lens, and hardware	843654151779	DPW-30
KT-RHLED-WG-3-KIT /G2	Wire guard kit for round highbay fixtures; Fits 400W round highbay fixture; Includes mounting hardware	843654151762	DHU-26
KT-RHLED-JBOX-PM /G2	J-Box; Optimized for pole pendant and step down transformer applications; Fits all round LED high bay fixtures	843654133300	RAQ-94

 <p>Surface Mount Kit KT-RHLED-SM-3-KIT /G2</p>		 <p>Aluminum Reflector Kit KT-RHLED-AR90-3-KIT /G2</p>	
 <p>J-Box KT-RHLED-JBOX-PM /G2</p>		 <p>Clear Polycarbonate Reflector KT-RHLED-CL90-3-KIT /G2</p>	

\* Screw in PIR sensors can not be used with KT-RHLED-CL90-2-KIT /G2

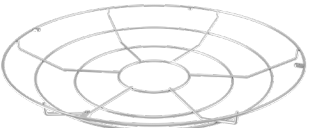

Wire Guard Kit  
KT-RHLED-WG-3-KIT /G2

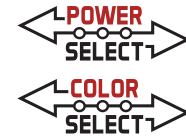

# KT-RHLED400PSHV-18C-8CSD-VDIM-P

## ROUND LED HIGH BAY FIXTURE

**FIXTURE ORDERING INFORMATION**

ORDER CODE	PACK QTY.	UPC	EASY CODE	DLC PRODUCT ID
KT-RHLED400PSHV-18C-8CSD-VDIM-P	1	843654156361	DRR-76	TBD
KT-RHLED400PSHV-18C-8CSD-VDIM-P /TAA	1	843654158648	MOM-25	TBD

**CATALOG NUMBER BREAKDOWN**

# KT-RHLED400PSHV-18C-8CSD-VDIM-P

<b>1</b>	<b>2</b>	<b>3</b>	<b>4</b>	<b>5</b>	<b>6</b>	<b>7</b>	<b>8</b>	<b>9</b>	<b>10</b>	<b>11</b>	<b>12</b>	<b>13</b>
<p><b>1 Keystone Technologies</b></p> <p><b>2 Fixture Type</b></p> <p><b>3 LED Technology</b></p> <p><b>4 Wattage</b></p> <p><b>5 Power Selectable</b></p> <p><b>6 High Voltage</b></p> <p><b>7 Size/Shape</b></p> <p><b>8 80 CRI</b></p> <p><b>9 Color Selectable</b></p> <p><b>10 Color Select Designation</b></p> <p><b>11 0-10V Dimming</b></p> <p><b>13 TAA Compliant</b></p>	<p><b>2 Fixture Type</b></p> <p style="border: 1px solid gray; padding: 2px;">RH Round High Bay</p>					<p><b>7 Size / Shape</b></p> <p style="border: 1px solid gray; padding: 2px;">18C 18" Diameter</p>			<p><b>10 Color Select Designation</b></p> <p style="border: 1px solid gray; padding: 2px;">D 4000/5000K</p>			<p><b>13 TAA Compliant</b></p> <p style="border: 1px solid gray; padding: 2px;">/TAA Made in Mexico</p>

**ORDERING EXAMPLES**

FIXTURE WITH SINGLE FACTORY-INSTALLED ACCESSORY

**KT-RHLED400PSHV-18C-8CSD-VDIM-P/FC3**

FIXTURE WITH NO FACTORY-INSTALLED ACCESSORIES

**KT-RHLED400PSHV-18C-8CSD-VDIM-P**

<b>KEYSTONE FIXTURE</b>
<b>CATALOG NUMBER</b>
KT-RHLED400PSHV-18C-8CSD-VDIM-P

<b>SENSORS</b>	
<input checked="" type="checkbox"/> <b>SUFFIX</b>	<b>CATALOG NUMBER</b>
<input checked="" type="checkbox"/> /FC3	KTSL-FC3-12V-PKO-PIR

\* When ordering more than one factory-installed accessory, use multiple suffixes as shown in the ordering examples above.  
**Note:** All accessories can also be ordered separately for field installation using just their regular Catalog Number, UPC, or Easy Code.