



KT-LED10DL-4CA-9CSF-DIM

4" SURFACE MOUNT DISK LIGHT

DESCRIPTION

4" Circular LED Residential Retrofit Disk Light

APPLICATION

Ideal for residential, hospitality, retail, and other retrofit and new construction applications



PRODUCT FEATURES

- Keystone Color Select technology (2700/3000/3500/4000/5000K)
- Ideal for retrofit, new construction, and remodel applications
- Flush-mount offers clean, modern appearance
- Diffused lens reduces glare
- Powered by Keystone TRIAC dimming LED driver; 10–100% dimming
- Ambient operating temperature: -25°C/-13°F to 40°C/104°F
- Suitable for use in wet locations
- Power factor: > 0.90
- Compliant with FCC Part 15, Subpart B, Class B

PERFORMANCE SPECIFICATIONS

Catalog Number	input Voltage	Wattage	CCT	Lumen Output	Efficacy	CRI	Beam Angle	Lifetime
KT-LED10DL-4CA-9CSF-DIM	120V	10W	2700K	700	70 lm/W	>90	110°	50,000 hrs
			3000K					
			3500K					
			4000K					
			5000K					

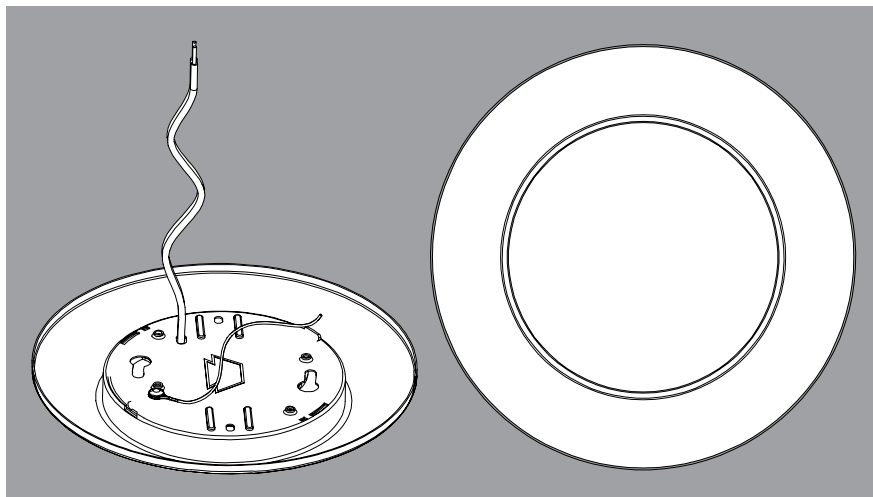

GENERAL WIRING DIAGRAM

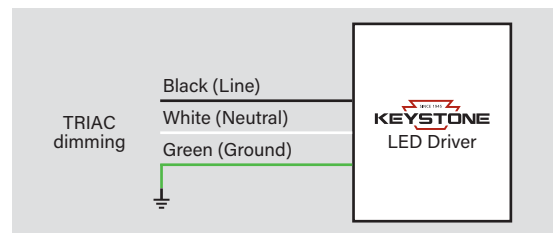



KT-LED10DL-4CA-9CSF-DIM

4" SURFACE MOUNT DISK LIGHT

PHOTOMETRICS SPECIFICATIONS

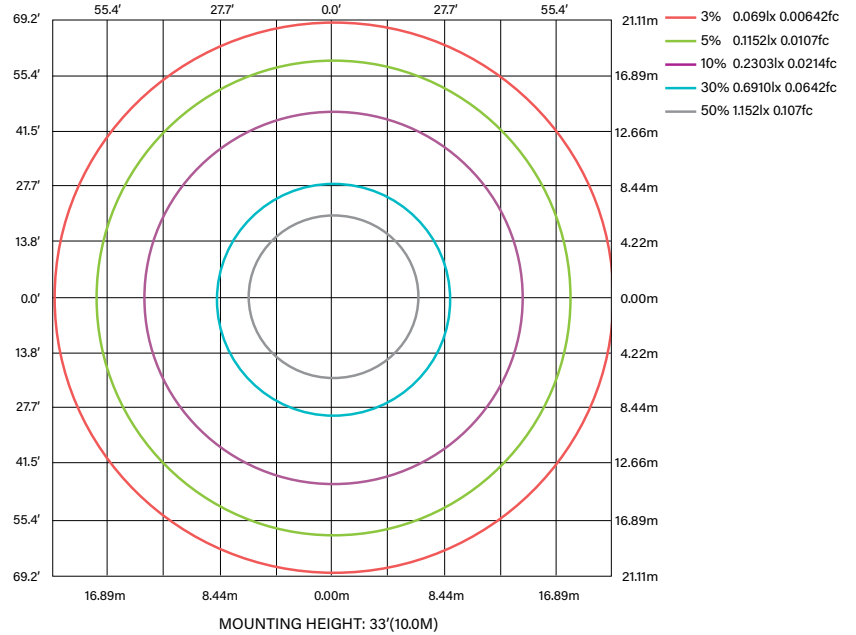
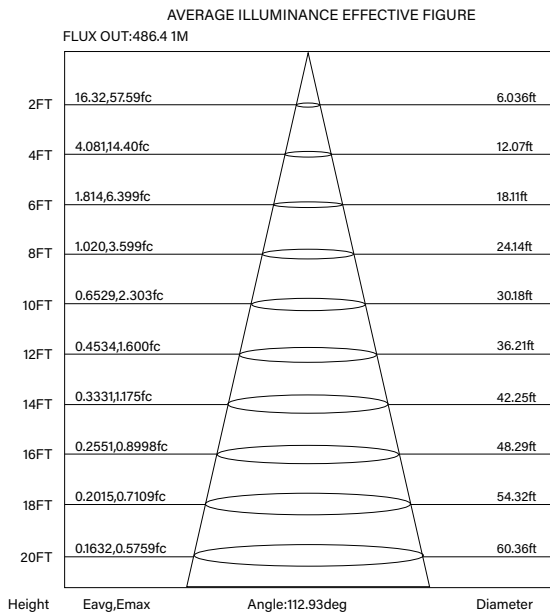
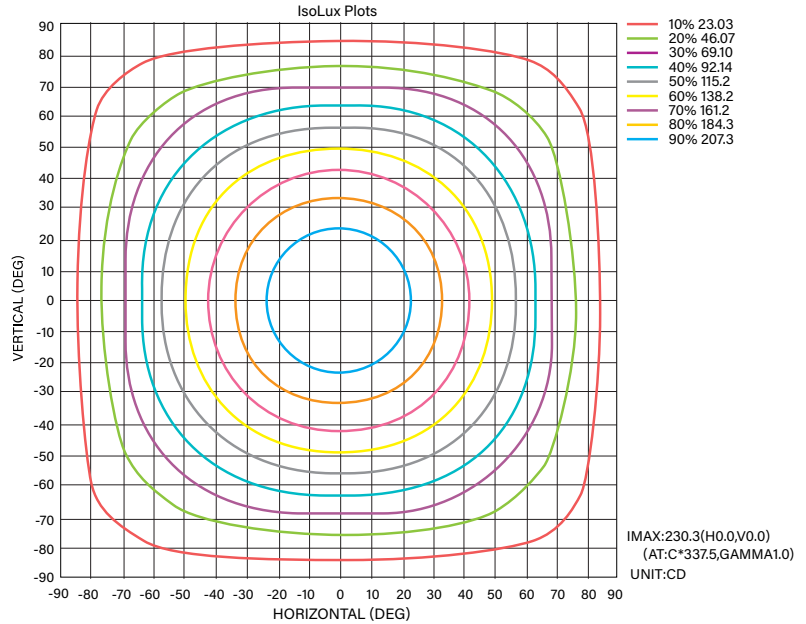
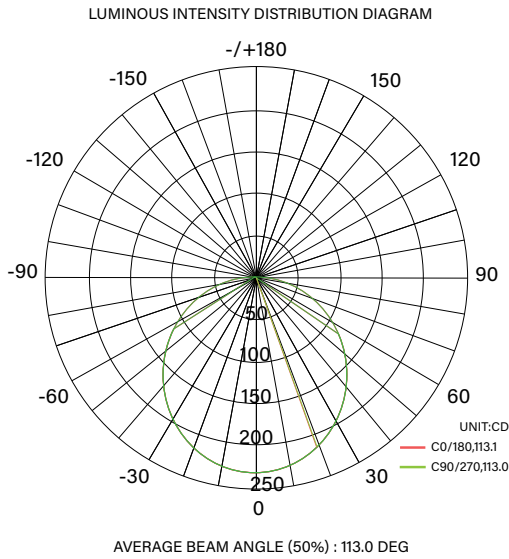

Note: The Curves indicate the illuminated area and the average illumination when the luminaire is at different distance.

KT-LED10DL-4CA-9CSF-DIM
4" SURFACE MOUNT DISK LIGHT

PHYSICAL SPECIFICATIONS

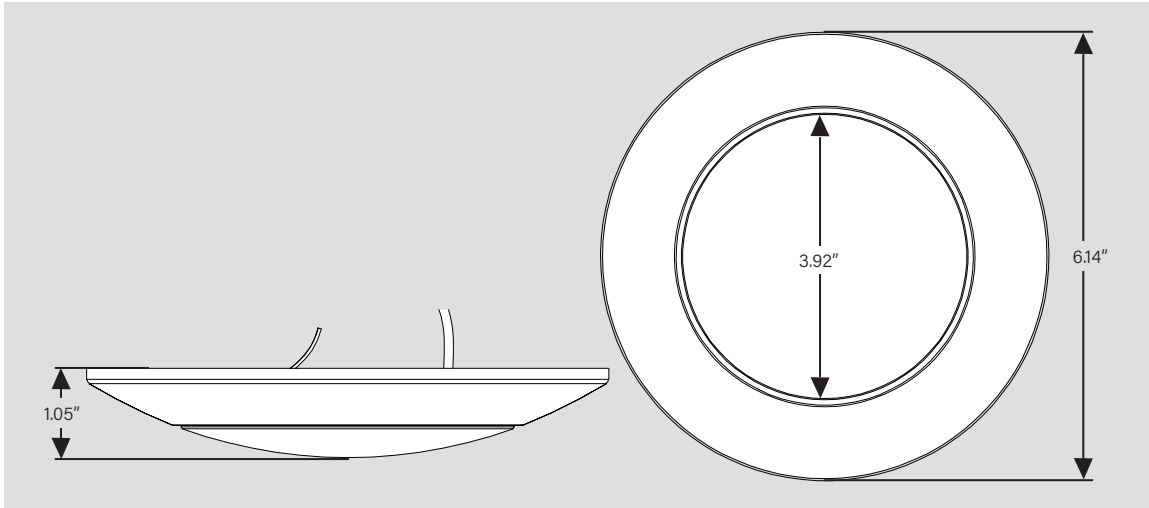

INSTALLATION INSTRUCTIONS

- 1.** Connect the luminaire to supply wires with the wire nuts (included).

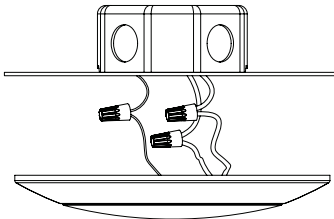

- 2.** Remove lens by turning counter clockwise to unlock.

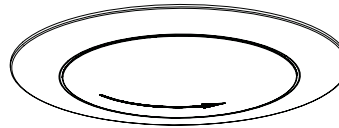

- 3.** Select desired CCT

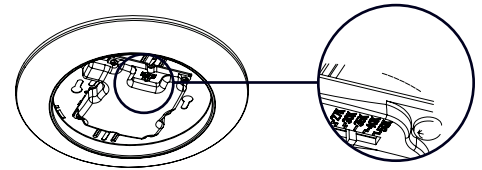

- 4.** Safely place all wires into the junction box, mount luminaire to the junction box and screws through the keyhole slots. 4" luminaires are compatible with 2.75" junction boxes.

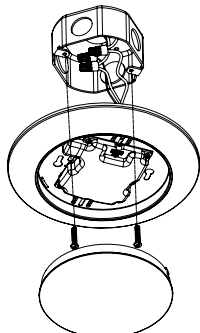

- 5.** Replace lens and twist clockwise to lock.

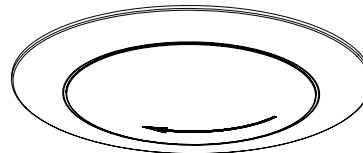



KT-LED10DL-4CA-9CSF-DIM

4" SURFACE MOUNT DISK LIGHT

ORDERING INFORMATION

Catalog Number	UPC	Easy Code	Energy Star Unique ID
KT-LED10DL-4CA-9CSF-DIM	843654156910	XFR-31	2473131

CATALOG NUMBER BREAKDOWN

KT-LED10DL-4CA-9CSF-DIM

- 1**
- 2**
- 3**
- 4**
- 5**
- 6**
- 7**
- 8**
- 9**
- 10**
- 11**

- 1 Keystone Technologies**
- 2 LED Technology**
- 3 Wattage**
- 4 Fixture Type**
 - DL** Disk Light
- 5 Nominal Size**
 - 4** 4" Nominal
- 6 Shape**
 - C** Circular
- 7 Designation**
 - A** Series A Design
- 10 Color Select Designation**
 - F** 2700/3000/3500/4000/5000K
- 11 Dimming**
 - DIM** TRIAC Dimmable