

KT-CLED60PS-M1-8CSB-VDIM-W

LED CANOPY LIGHT FIXTURE

DESCRIPTION

General Purpose LED Canopy Light | Power Select 60/50/40W |
Color Select 3000/4000/5000K | 120–277V Input | White Housing

APPLICATION

Ceiling mounted outdoor illumination needs, such as parking garages, covered walkways, entrance areas, etc.



10 YEAR
LIMITED WARRANTY



PRODUCT FEATURES

- Keystone Power Select technology (60/50/40W)
- Keystone Color Select technology (3000/4000/5000K)
- Familiar, low profile design ideal for a wide range of new and replacement installations
- Heavy-duty die-cast aluminum housing with a modern aesthetic and (3) 1/2" NPT threaded conduit hubs
- Suitable for standard junction box mounting or 3/4" NPT pendant mounting
- Built-in dusk-to-dawn photocell behind translucent 3/4" threaded plug with anti-yellowing agent
- Impact-resistant, polycarbonate diffuser with 160° parking garage distribution. Perfect for low mounting applications
- Suitable for California Title 24 (Part 6) code compliance requirements when used with suitable sensor / control device(s)
- Optional 110° canopy distribution diffuser available. Perfect for high mounting applications
- Compatible with KTS-MW3-12V-PKO, quick install bi-level occupancy sensor accessory available
- Compatible with KTSL-FC4-12V-PKO, SmartLoop Bluetooth wireless controller accessory available
- Powered by Keystone LED 0–10V dimming driver
- Ambient operating temperature: –40°C/–40°F to 50°C/122°F
- UL certified for wet locations, IP65 rated
- Power Factor: > 0.95
- THD: < 20%
- L70 @ >100,000 hrs @ 25°C/77°F ambient fixture temperature
- Meets FCC Part 15, Part B, Class A standards for conducted and radiated emissions

PERFORMANCE SPECIFICATIONS

Catalog Number	Selectable Wattage	Selectable CCT	Lumens	Efficacy	Input Voltage	Dimming	CRI	Distribution Pattern	Photocell Included	Nominal Size	Housing Color	Legacy Equivalent
KT-CLED60PS-M1-8CSB-VDIM-W	60W	3000K	7500	125 lm/W	120–277V	0–10V	> 80	160°	Yes	10" square	White	250W MH
		4000K	8400	140 lm/W								
		5000K	7800	130 lm/W								
	50W	3000K	6250	125 lm/W								
		4000K	7000	140 lm/W								
		5000K	6500	130 lm/W								
	40W	3000K	5000	125 lm/W								
		4000K	5600	140 lm/W								
		5000K	5200	130 lm/W								

Note: Preset to highest lumen output (60W/5000K)

Note: Color uniformity: CCT (Correlated Color Temperature) range as per guidelines outlined in ANSI C78.377-2017

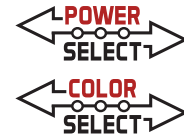

KT-CLED60PS-M1-8CSB-VDIM-W

LED CANOPY LIGHT FIXTURE

PHOTOMETRIC SPECIFICATIONS

ISOCANDELA PLOT

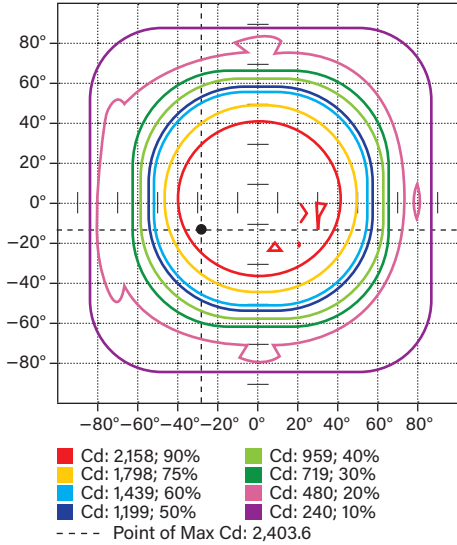

POLAR CANDELA DISTRIBUTION

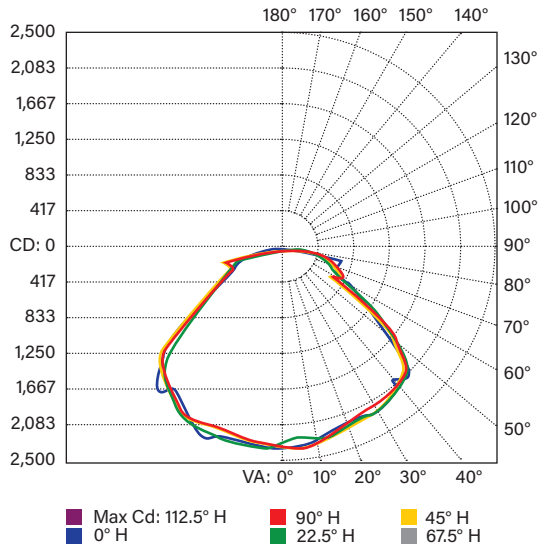

ZONAL LUMEN SUMMARY

Zone	Lumens	% Luminaire
0-30	1,903.5	24.7%
0-40	3,296.9	42.8%
0-60	5,945.7	77.2%
60-90	1,530.4	19.9%
70-100	887.7	11.5%
90-120	180.4	2.3%
0-90	7,476.1	97.0%
90-180	229.2	3.0%
0-180	7,705.3	100%

POWER SELECT (WATTAGE) AND COLOR SELECT (CCT) ADJUSTMENT

This fixture is equipped with field-adjustable Keystone Power Select and Color Select technology.

1. Ensure power is off to the fixture.
2. Remove knockouts.
3. Adjust dip switches to desired settings.
4. Replace knockouts.
5. Restore power to fixture.

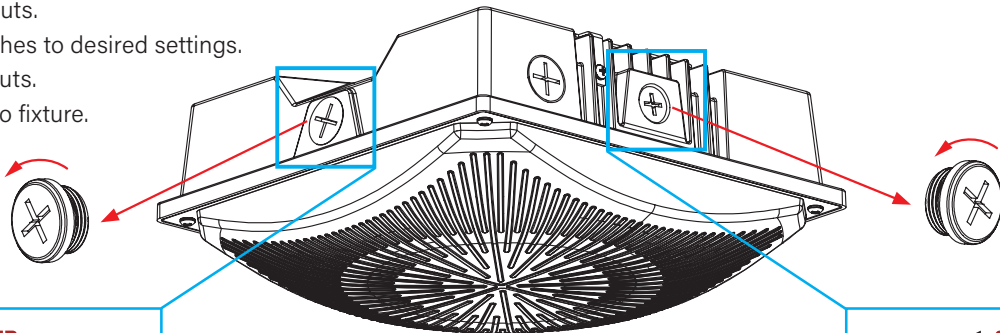

POWER SELECT ADJUSTMENT SWITCH
Set dip switch to adjust wattage between 40W, 50W, and 60W. Fixture comes preset at 60W.

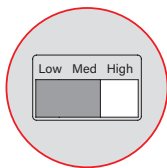

PHOTOCELL ON/OFF SWITCH

Set dip switch to turn on or turn off built-in photocell.

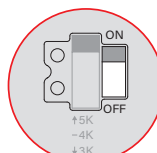

COLOR SELECT ADJUSTMENT SWITCH
Set dip switch to adjust CCT between 3000K, 4000K, and 5000K. Fixture comes preset at 5000K.

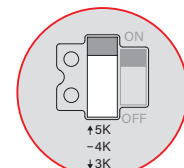

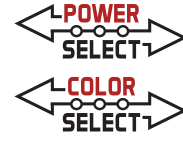

KT-CLED60PS-M1-8CSB-VDIM-W LED CANOPY LIGHT FIXTURE

DIMENSIONS

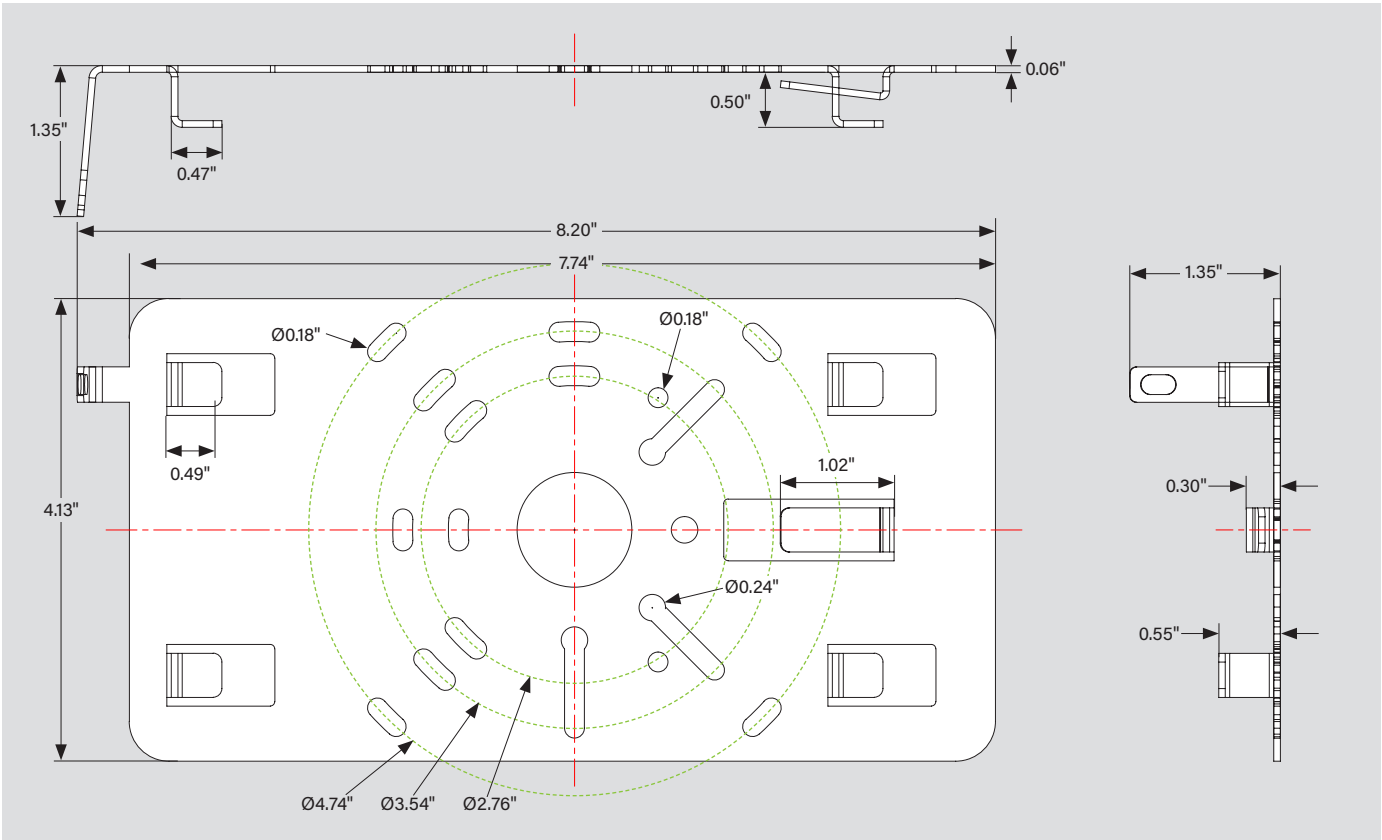
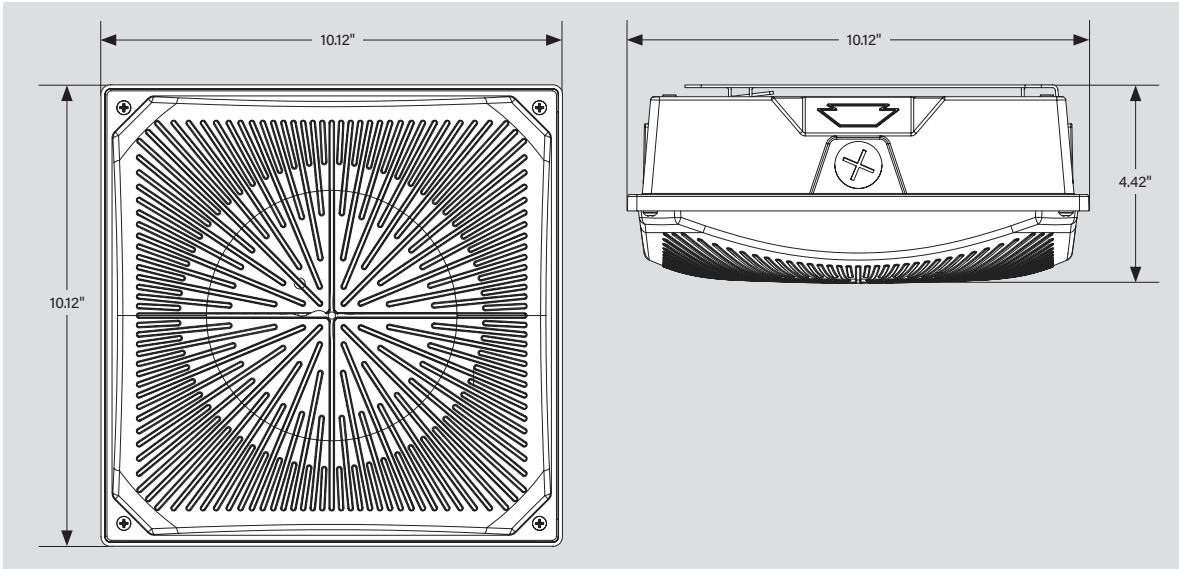

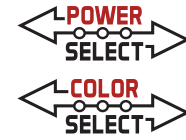

KT-CLED60PS-M1-8CSB-VDIM-W

LED CANOPY LIGHT FIXTURE

WIRING DIAGRAMS

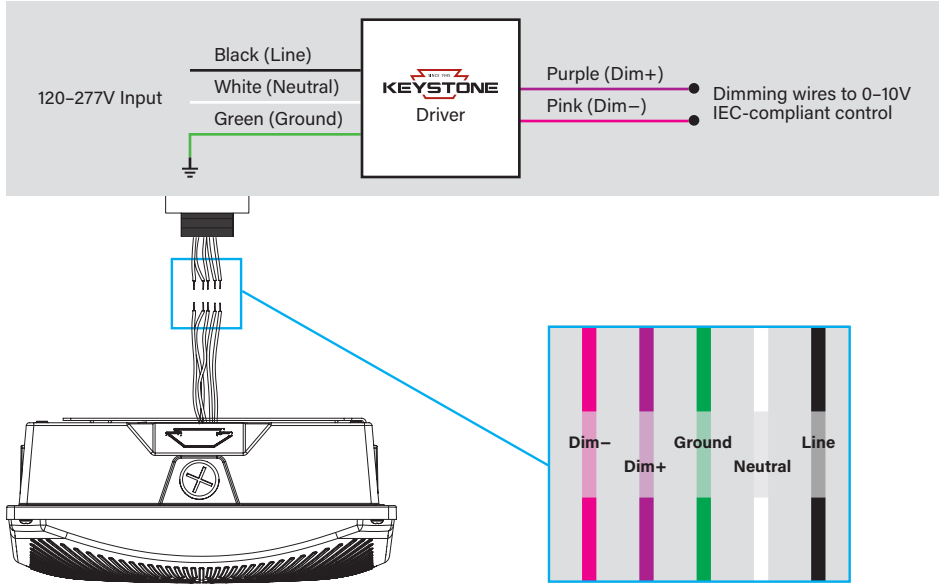

ACCESSORIES

SENSORS / CONTROLLERS

Factory-Installable OR Field-Installable (field-installable purchased separately)

✓	SUFFIX*	CATALOG NUMBER	DESCRIPTION	UPC	EASY CODE
	/FC4	KTSL-FC4-12V-PKO	Bluetooth mesh wireless screw-in low voltage fixture controller for SmartLoop system	843654149066	RUN-10
	/MW3	KTS-MW3-12V-PKO	12V Microwave Occupancy Sensor	843654135212	TRM-32



LENSES

Factory-Installable OR Field-Installable (field-installable purchased separately)

✓	SUFFIX*	CATALOG NUMBER	DESCRIPTION	UPC	EASY CODE
	/L110	KT-CLED-LENS-M1-110-KIT	110° beam angle lens Used on 10" square canopy	843654152004	AHD-34

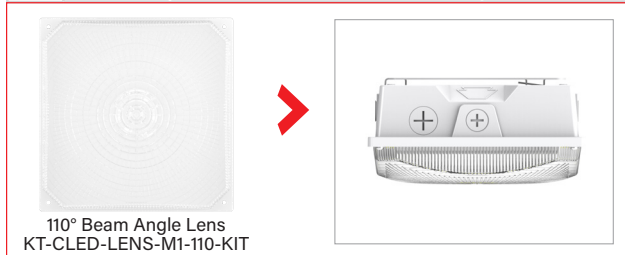

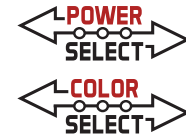

KT-CLED60PS-M1-8CSB-VDIM-W

LED CANOPY LIGHT FIXTURE

MOUNTS AND BRACKETS

Field-Installable / Field-Use ONLY (purchased separately)

CATALOG NUMBER	DESCRIPTION	UPC	EASY CODE
KT-CLED-BP-15-W	15" mounting back plate White Used on all canopy fixtures	843654152035	CEU-41
KT-CLED-SM-1-KIT-W	Surface mount / pendant mount kit White Used on series 1 canopy fixtures Attaches to pre-installed mounting plate	843654160375	ZDU-78

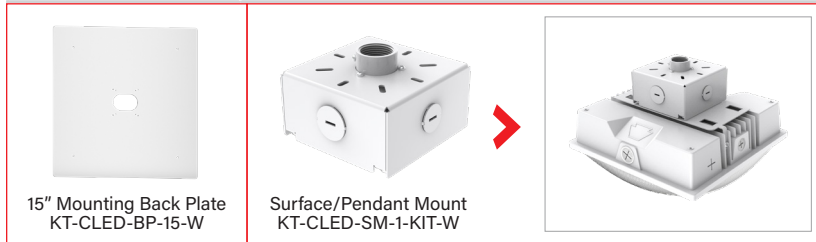

** For factory installation of accessory, add suffix to fixture part number (see ordering examples and instructions on last page of spec sheet).*

FIXTURE ORDERING INFORMATION

ORDER CODE	UPC	EASY CODE	DLC PRODUCT ID
KT-CLED60PS-M1-8CSB-VDIM-W	843654160146	XEC-85	S-TU8M9J
KT-CLED60PS-M1-8CSB-VDIM-W /L110	843654163147	GEV-30	S-0AXF86
			S-UO7Y3A

FIXTURE CATALOG NUMBER BREAKDOWN

KT-CLED60PS-M1-8CSB-VDIM-W

- | | | | | | | | | | | | | | |
|--------------------------------|-------------------------------|-------------------------|----------------------|---------------------------------|----------------------|-------------------|-----------------|----------------------------------|--|-------------------------|---|---|-------|
| 1 | 2 | 3 | 4 | 5 | 6 | 7 | 8 | 9 | 10 | 11 | 12 | | |
| 1 Keystone Technologies | 2 Canopy Light Fixture | 3 LED Technology | 4 Max Wattage | 5 Power Select 60/50/40W | 6 Medium Size | 7 Series 1 | 8 80 CRI | 9 Color Select Technology | 10 Color Select 3000/4000/5000K | 11 0-10V Dimming | 12 Housing Color | | |
| | | | | | | | | | | | <table border="1" style="margin-left: auto; margin-right: auto;"> <tr> <td style="width: 50px;">W</td> <td style="width: 50px;">White</td> </tr> </table> | W | White |
| W | White | | | | | | | | | | | | |

ORDERING EXAMPLES

FIXTURE WITH MULTIPLE FACTORY-INSTALLED ACCESSORIES*

KT-CLED60PS-M1-8CSB-VDIM-W/FC4/L110

FIXTURE WITH SINGLE FACTORY-INSTALLED ACCESSORY

KT-CLED60PS-M1-8CSB-VDIM-W/FC4

FIXTURE WITH NO FACTORY-INSTALLED ACCESSORIES

KT-CLED60PS-M1-8CSB-VDIM-W

** When ordering more than one factory-installed accessory, use multiple suffixes as shown in the ordering examples above.
 Note: All accessories can also be ordered separately for field installation using just their regular Catalog Number, UPC, or Easy Code.*

KEYSTONE FIXTURE	
CATALOG NUMBER	
KT-CLED60PS-M1-8CSB-VDIM-W	
SENSORS / CONTROLLERS	
SUFFIX	CATALOG NUMBER
✓ /FC4	KTSL-FC4-12V-PKO
LENSES	
SUFFIX	CATALOG NUMBER
✓ /L110	KT-CLED-LENS-S1-110-KIT