



KT-ALEDXXXPS-X2-OSA-NM-8CSB-VDIM-X

LED AREA LIGHT FIXTURE

DESCRIPTION

Power and Color Select Area Light with Optic Swap | 120-277V Input | Black or Silver Housing | Multiple Mounting, Optics, and Control Options

APPLICATION

Pole-mount or structure-mount outdoor illumination needs (including parking lots, auto dealerships, pathways, roadways, recreational venues, and other general area lighting requirements)



10 YEAR
LIMITED WARRANTY

PRODUCT FEATURES

- Keystone Power Select technology (See Performance Specifications for details)
- Keystone Color Select technology (3000/4000/5000K)
- Innovative optic swap capability under door frame and latch design for quick, tool-free lens change
- Two lenses in the box: Type III installed, Type V included
- Type II and Type IV lenses sold separately. See below for details
- Heavy-duty, die-cast aluminum housing with ample heat sinking
- Low-profile design delivers high-performance illumination and improves application site aesthetics
- True U0 design for dark sky friendly performance that eliminates undesirable sky glow
- Integrated NEMA/ANSI C126.10 3-pin twist-lock receptacle with shorting cap. Compatible with KT-TLP-UV-3PN, 120-277V photocell (See Accessories section for details).
- Two easy to use mounting options available (sold separately): slip fitter mount and adjustable pole mount for square and round poles.
- Keystone 0-10V dimming driver
- Ambient operating temperature: -40°C/-40°F to 50°C/122°F
- UL Certified; IP65 rated
- Power factor: > 0.95
- THD: < 20%
- LED chip lifetime: L70 > 100,000 hrs @ 25°C/77°F ambient fixture temperature
- Meets FCC Part 15, Part B, Class A standards for conducted and radiated emissions

PERFORMANCE SPECIFICATIONS

Catalog No.	Selectable Wattage	Selectable CCT	Lumens	Efficacy	Input Voltage	Dimming	CRI	Distribution Pattern*	Photocell Included	Housing Color**	Legacy Equivalent
KT-ALED140PS-M2-OSA-NM-8CSB-VDIM-B KT-ALED140PS-M2-OSA-NM-8CSB-VDIM-S	140W	3000K	17,950	128 lm/W	120-277V	0-10V	> 80	Type III Installed, Type V Included	No	Black or Silver Available	400W MH
		4000K	20,780	148 lm/W							
		5000K	19,020	136 lm/W							
	100W	3000K	12,720	127 lm/W							
		4000K	14,750	148 lm/W							
		5000K	13,530	135 lm/W							
	70W	3000K	9310	133 lm/W							
		4000K	10,740	153 lm/W							
		5000K	9,880	141 lm/W							
KT-ALED290PS-L2-OSA-NM-8CSB-VDIM-B KT-ALED290PS-L2-OSA-NM-8CSB-VDIM-S	290W	3000K	36,320	125 lm/W	120-277V	0-10V	> 80	Types II and IV Available, Sold Separately	No	Black or Silver Available	1000W MH
		4000K	42,770	147 lm/W							
		5000K	38,700	133 lm/W							
	210W	3000K	27,300	130 lm/W							
		4000K	31,710	151 lm/W							
		5000K	28,980	138 lm/W							
	185W	3000K	22,970	124 lm/W							
		4000K	27,060	146 lm/W							
		5000K	24,440	132 lm/W							

* For more information, see Accessories page below or contact Keystone with questions.

** Fixtures (and mounts) with alternate housing colors are available and made to order. Extended lead times apply. Please see catalog number breakdown for full ordering code details.

KT-ALEDXXXPS-X2-OSA-NM-8CSB-VDIM-X

LED AREA LIGHT FIXTURE

PHYSICAL SPECIFICATIONS

LED AREA LIGHT FIXTURE

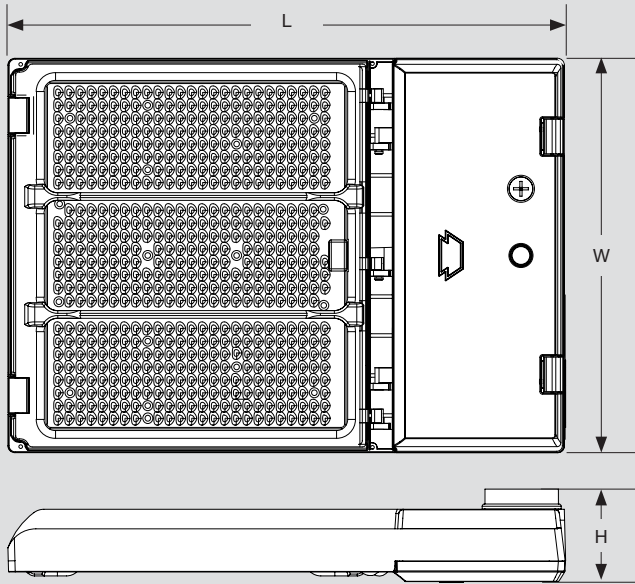

FIXTURE DIMENSIONS

Catalog Number	L (Length)	W (Width)	H (Height)
KT-ALED140PS-M2-OSA-NM-8CSB-VDIM-B KT-ALED140PS-M2-OSA-NM-8CSB-VDIM-S	15.70"	11.18"	3.30"
KT-ALED290PS-L2-OSA-NM-8CSB-VDIM-B KT-ALED290PS-L2-OSA-NM-8CSB-VDIM-B	19.72"	13.97"	3.30"

PACKAGING DIMENSIONS

Catalog Number	Carton Dimensions	Carton Weight
KT-ALED140PS-M2-OSA-NM-8CSB-VDIM-B KT-ALED140PS-M2-OSA-NM-8CSB-VDIM-S	5.63" x 13.15" x 21.65"	12.35 lbs
KT-ALED290PS-L2-OSA-NM-8CSB-VDIM-B KT-ALED290PS-L2-OSA-NM-8CSB-VDIM-B	5.63" x 15.95" x 26.18"	17.53 lbs

POLE MOUNT (ADJUSTABLE OR FIXED) DRILLING HOLES

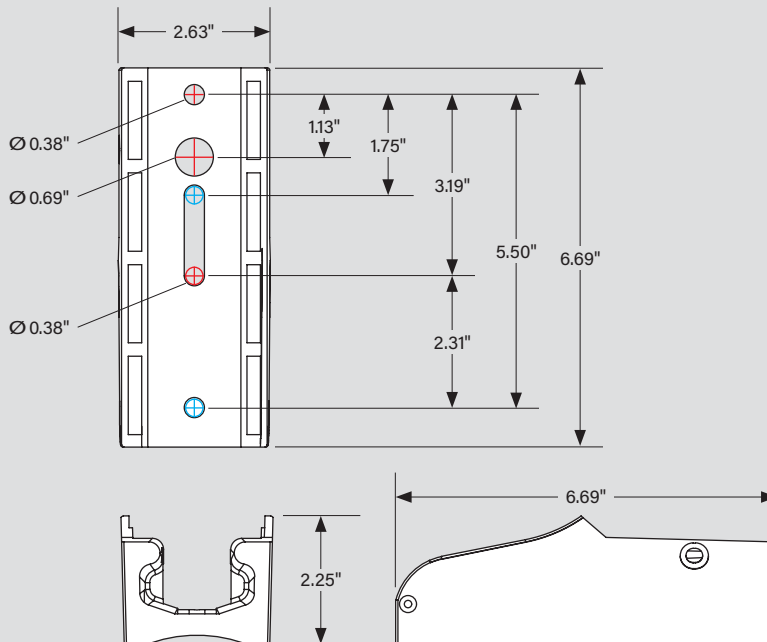



KT-ALEDXXXPS-X2-OSA-NM-8CSB-VDIM-X

LED AREA LIGHT FIXTURE

WIRING DIAGRAM

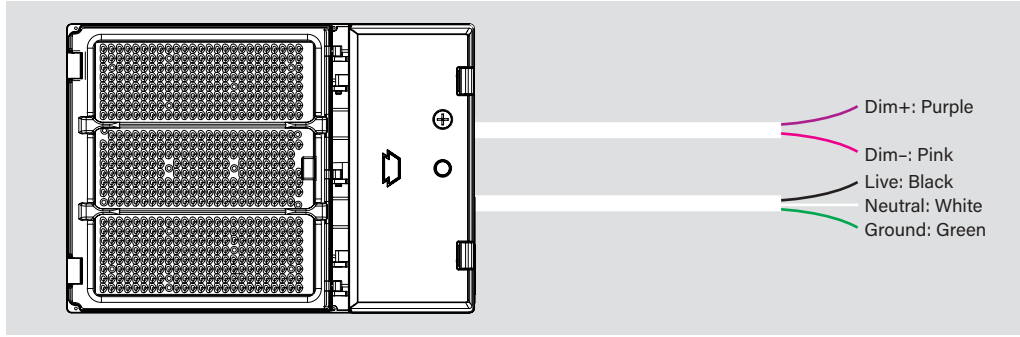

- Make input connections as needed and ensure connections are protected from exposure to the elements.
- **Input voltage rating: 120-277V**
- Ensure that input voltage on site matches the fixture you intend to install.

POWER SELECT (WATTAGE) AND COLOR SELECT (CCT) ADJUSTMENT

This fixture is equipped with field-adjustable Keystone Power Select and Color Select technology.

1. Ensure power is off to the fixture.
2. Open the driver compartment located on the underside of the fixture.
3. Adjust switches to desired settings.

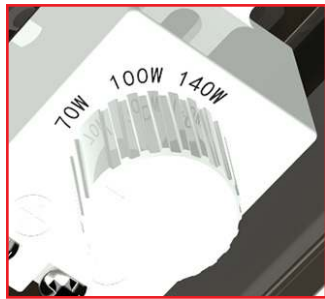

POWER SELECT ADJUSTMENT DIAL
Adjust between high, medium, and low wattage. Fixtures come preset to highest wattage.

Image for reference only. Different SKU's will have different wattages

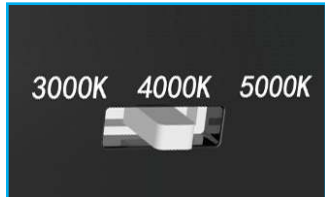

COLOR SELECT ADJUSTMENT SWITCH
Set switch to adjust CCT between 3000K, 4000K, and 5000K. Fixture comes preset at 5000K.

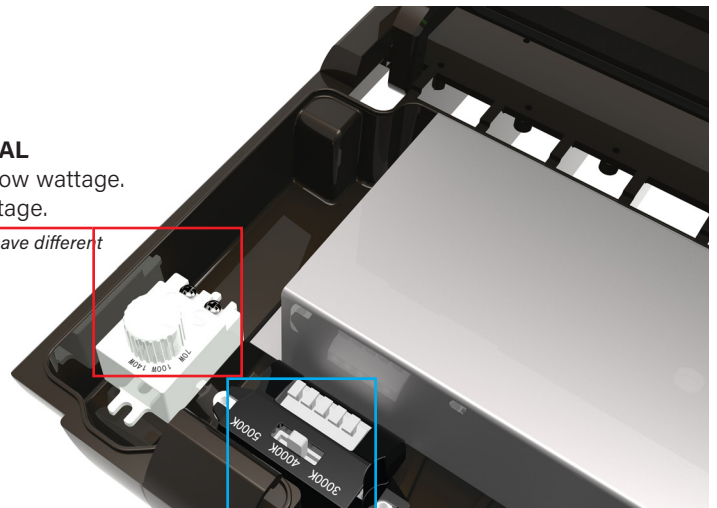

LIGHT DISTRIBUTION PATTERN

Photometric layouts for general reference only. Each square is 10 ft x 10 ft

KT-ALED140PS-M2-OSB-NM-8CSB-VDIM-X
Pole mounted at 30 ft

KT-ALED290PS-L2-OSA-NM-8CSB-VDIM-X
Pole mounted at 35 ft

- 0.1fc
- 0.2fc
- 0.5fc
- 1fc
- 2fc
- 5fc
- 10fc

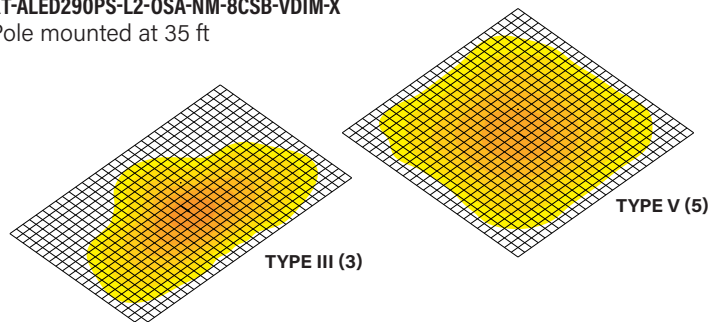
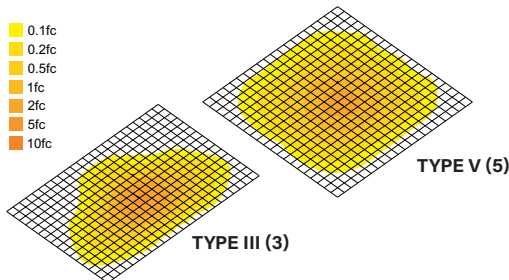



KT-ALEDXXXPS-X2-OSA-NM-8CSB-VDIM-X

LED AREA LIGHT FIXTURE

PHOTOMETRIC SPECIFICATIONS KT-ALED140PS-M2-OSA-NM-8CSB-VDIM-X (TYPE II [2])

ISOCANDELA PLOT

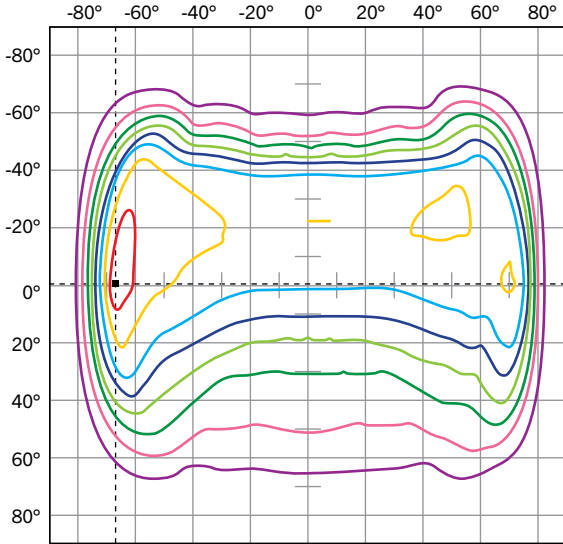

- Point of Max Cd: 9029.9
- Cd: 8051, 90%
- Cd: 6709, 75%
- Cd: 5367, 60%
- Cd: 4473, 50%
- Cd: 3578, 40%
- Cd: 2684, 30%
- Cd: 1789, 20%
- Cd: 895, 10%

POLAR CANDELA DISTRIBUTION

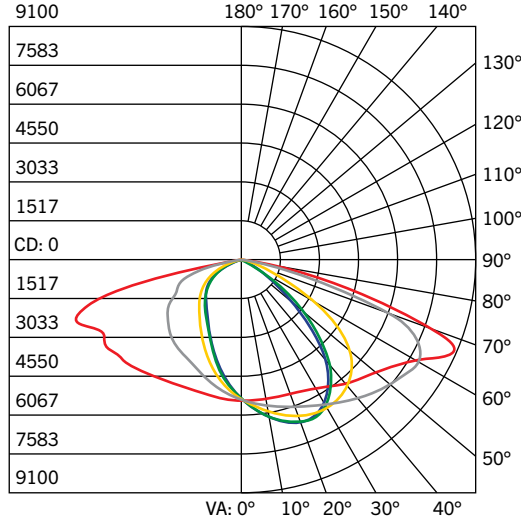

- : 0° H
- : 22.5° H
- : 67.5° H
- : 90° H
- : 45° H

FLUX DISTRIBUTION

Zone	Lumens	% Luminaire
Forward Light		
0°-30°	2635.6	14.2%
30°-60°	6056.9	32.6%
60°-80°	2427.6	13.1%
80°-90°	86.6	0.5%
Back Light		
0°-30°	1792.1	9.6%
30°-60°	3633.2	19.5%
60°-80°	1887.1	10.2%
80°-90°	71.0	0.4%
Up Light		
90°-100°	0.0	0.0%
100°-180°	0.0	0.0%
Total	18590.1	100.0%
BUG Rating	B3-U0-G3	

PHOTOMETRIC SPECIFICATIONS KT-ALED140PS-M2-OSA-NM-8CSB-VDIM-X (TYPE III [3])

ISOCANDELA PLOT

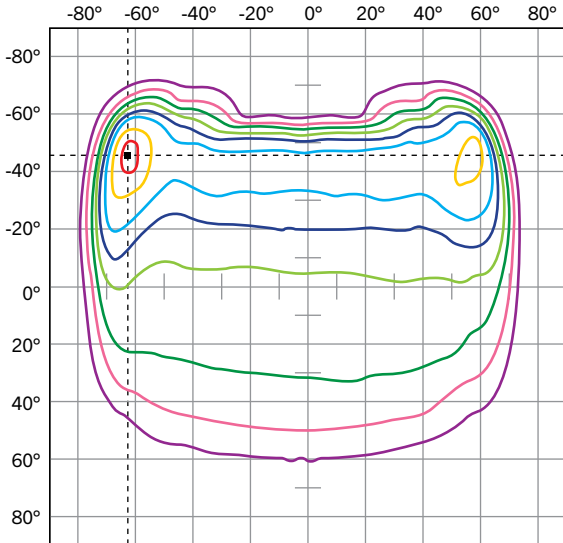

- Point of Max Cd: 11595.9
- Cd: 10278, 90%
- Cd: 8565, 75%
- Cd: 6852, 60%
- Cd: 5710, 50%
- Cd: 4568, 40%
- Cd: 3426, 30%
- Cd: 2284, 20%
- Cd: 1142, 10%

POLAR CANDELA DISTRIBUTION

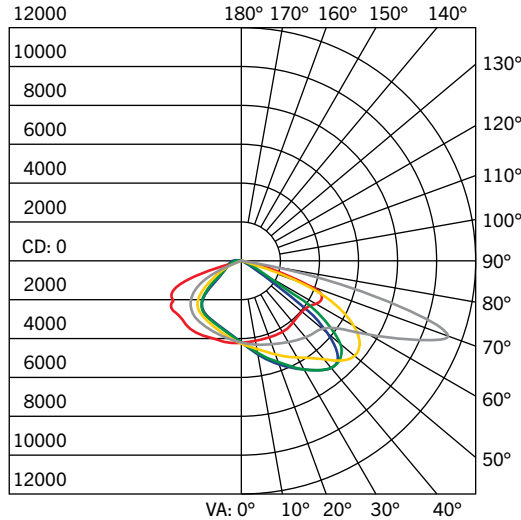

- : 0° H
- : 22.5° H
- : 67.5° H
- : 90° H
- : 45° H

FLUX DISTRIBUTION

Zone	Lumens	% Luminaire
Forward Light		
0°-30°	2171.9	11.5%
30°-60°	6942.9	36.9%
60°-80°	3378.3	17.9%
80°-90°	65.9	0.4%
Back Light		
0°-30°	1621.8	8.6%
30°-60°	3565.3	18.9%
60°-80°	1049.9	5.6%
80°-90°	36.4	0.2%
Up Light		
90°-100°	0.0	0.0%
100°-180°	0.0	0.0%
Total	18832.4	100.0%
BUG Rating	B3-U0-G3	

KT-ALEDXXXPS-X2-OSA-NM-8CSB-VDIM-X

LED AREA LIGHT FIXTURE

PHOTOMETRIC SPECIFICATIONS KT-ALED140PS-M2-OSA-NM-8CSB-VDIM-X (TYPE IV [4])

ISOCANDELA PLOT

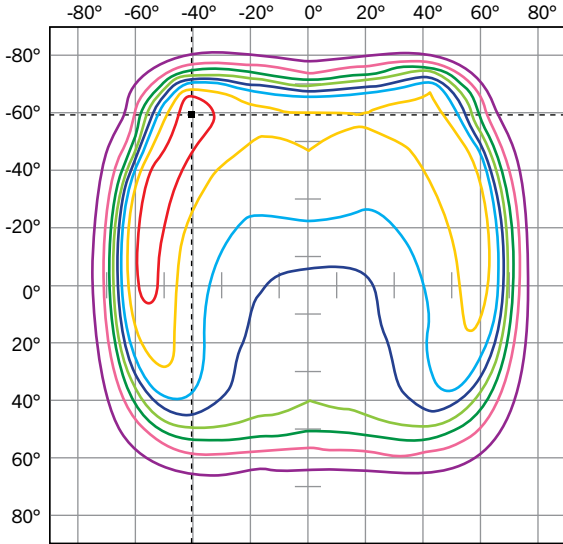

POLAR CANDELA DISTRIBUTION

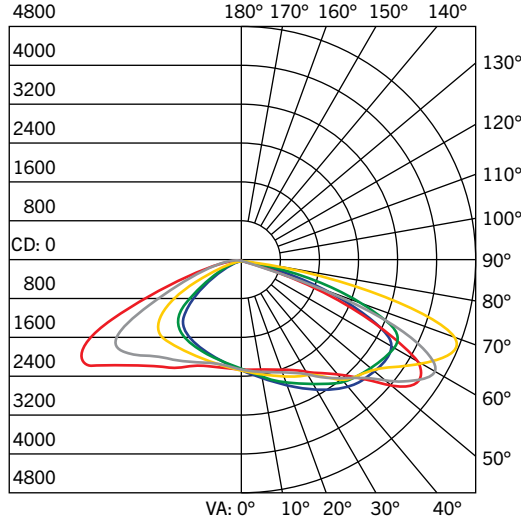

FLUX DISTRIBUTION

Zone	Lumens	% Luminaire
Forward Light		
0°-30°	1628.1	8.8%
30°-60°	5903.8	32.1%
60°-80°	3949.0	21.4%
80°-90°	152.1	0.8%
Back Light		
0°-30°	1411.5	7.7%
30°-60°	4065.2	22.1%
60°-80°	1269.2	6.9%
80°-90°	35.3	0.2%
Up Light		
90°-100°	0.0	0.0%
100°-180°	0.0	0.0%
Total	18414.2	100.0%
BUG Rating	B3-U0-G3	

PHOTOMETRIC SPECIFICATIONS KT-ALED140PS-M2-OSA-NM-8CSB-VDIM-X (TYPE V [5])

ISOCANDELA PLOT

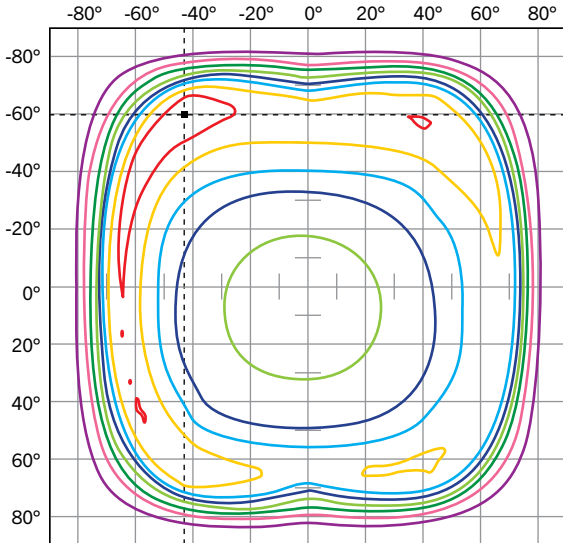

POLAR CANDELA DISTRIBUTION

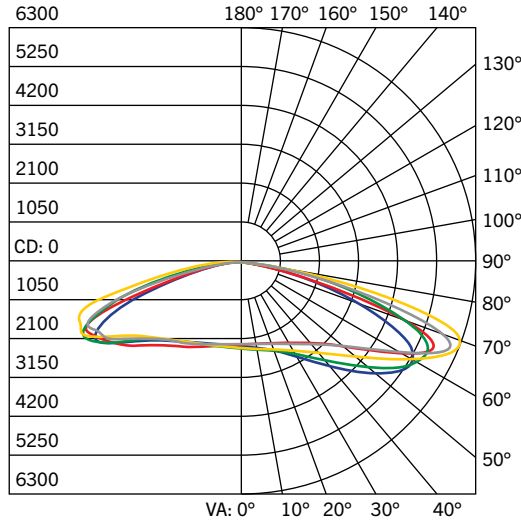

FLUX DISTRIBUTION

Zone	Lumens	% Luminaire
Forward Light		
0°-30°	1056.8	5.6%
30°-60°	4393.8	23.3%
60°-80°	4321.3	23.0%
80°-90°	233.7	1.2%
Back Light		
0°-30°	995.5	5.3%
30°-60°	3593.6	19.1%
60°-80°	3986.6	21.2%
80°-90°	238.8	1.3%
Up Light		
90°-100°	0.0	0.0%
100°-180°	0.0	0.0%
Total	18820.1	100.0%
BUG Rating	B4-U0-G3	

KT-ALEDXXXPS-X2-OSA-NM-8CSB-VDIM-X

LED AREA LIGHT FIXTURE

PHOTOMETRIC SPECIFICATIONS KT-ALED290PS-L2-OSA-NM-8CSB-VDIM-X (TYPE II [2])

ISOCANDELA PLOT

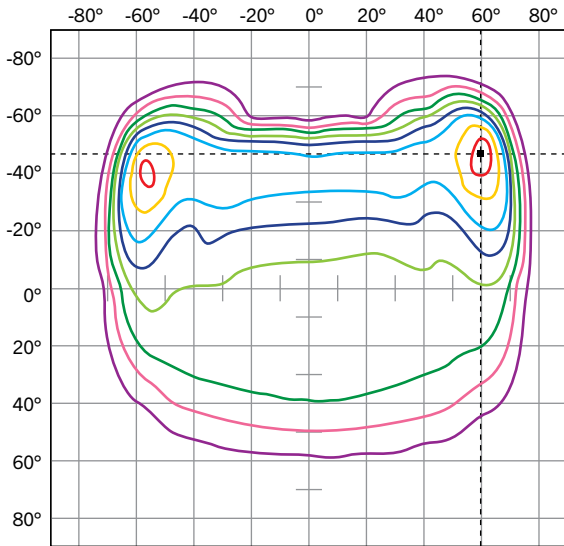

- Point of Max Cd: 24472.5
- Cd: 21625, 90%
 - Cd: 18020, 75%
 - Cd: 14416, 60%
 - Cd: 12014, 50%
 - Cd: 9611, 40%
 - Cd: 7208, 30%
 - Cd: 4805, 20%
 - Cd: 2403, 10%

POLAR CANDELA DISTRIBUTION

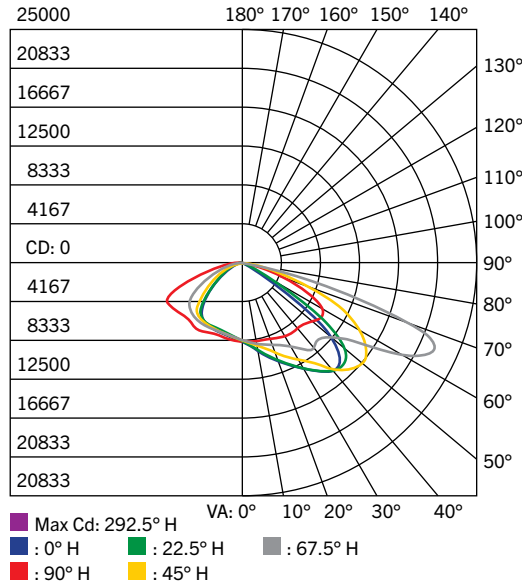

- Max Cd: 292.5° H
- : 0° H
- : 90° H
- : 22.5° H
- : 45° H
- : 67.5° H

FLUX DISTRIBUTION

Zone	Lumens	% Luminaire
Forward Light		
0°-30°	4351.7	10.9%
30°-60°	14745.1	37.0%
60°-80°	7342.5	18.4%
80°-90°	181.0	0.5%
Back Light		
0°-30°	3433.4	8.6%
30°-60°	7633.2	19.2%
60°-80°	2037.6	5.1%
80°-90°	76.3	0.2%
Up Light		
90°-100°	0.0	0.0%
100°-180°	0.0	0.0%
Total	39800.8	100.0%
BUG Rating	B4-U0-G3	

PHOTOMETRIC SPECIFICATIONS KT-ALED290PS-L2-OSA-NM-8CSB-VDIM-X (TYPE III [3])

ISOCANDELA PLOT

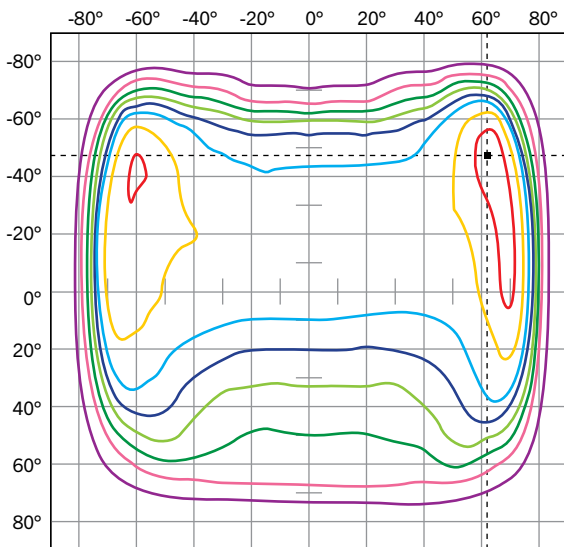

- Point of Max Cd: 15289.9
- Cd: 13624, 90%
 - Cd: 11368, 75%
 - Cd: 9095, 60%
 - Cd: 7579, 50%
 - Cd: 6063, 40%
 - Cd: 4547, 30%
 - Cd: 3032, 20%
 - Cd: 1516, 10%

POLAR CANDELA DISTRIBUTION

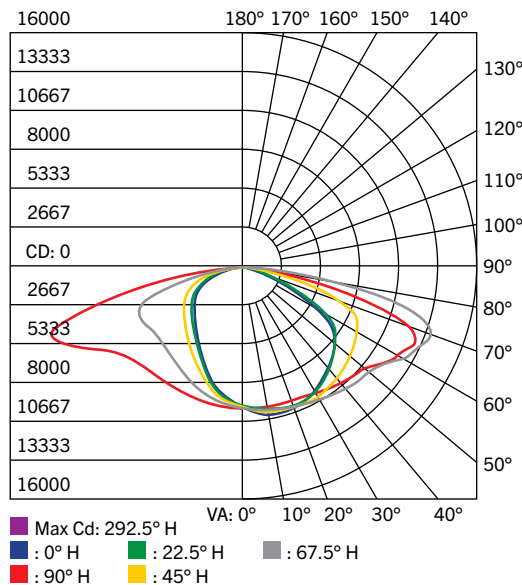

- Max Cd: 292.5° H
- : 0° H
- : 90° H
- : 22.5° H
- : 45° H
- : 67.5° H

FLUX DISTRIBUTION

Zone	Lumens	% Luminaire
Forward Light		
0°-30°	4375.3	11.0%
30°-60°	11377.5	38.6%
60°-80°	7372.5	18.6%
80°-90°	503.8	1.3%
Back Light		
0°-30°	3570.4	9.0%
30°-60°	7690.4	19.4%
60°-80°	4636.1	11.7%
80°-90°	200.5	0.5%
Up Light		
90°-100°	0.0	0.0%
100°-180°	0.0	0.0%
Total	39726.5	100.0%
BUG Rating	B4-U0-G4	

KT-ALEDXXXPS-X2-OSA-NM-8CSB-VDIM-X

LED AREA LIGHT FIXTURE

PHOTOMETRIC SPECIFICATIONS KT-ALED290PS-L2-OSA-NM-8CSB-VDIM-X (TYPE IV [4])

ISOCANDELA PLOT

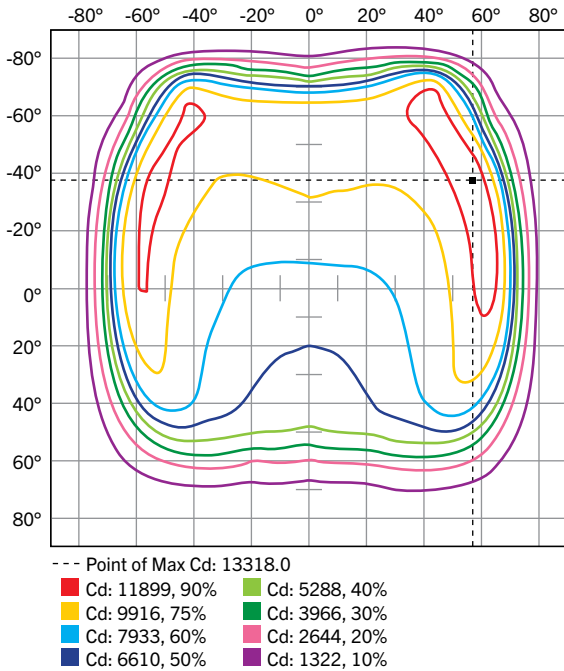

POLAR CANDELA DISTRIBUTION

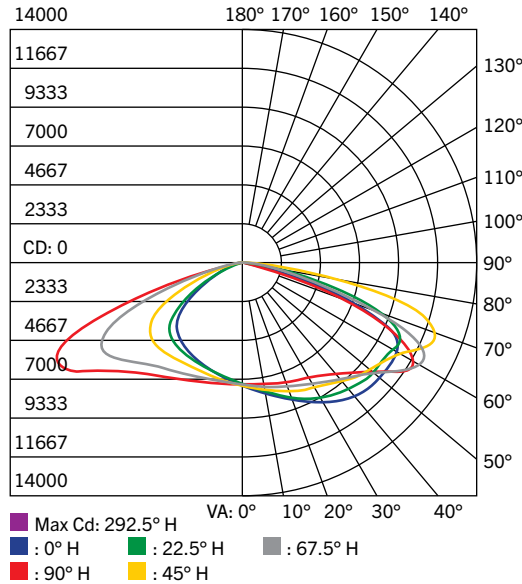

FLUX DISTRIBUTION

Zone	Lumens	% Luminaire
Forward Light		
0°-30°	3496.9	8.9%
30°-60°	11626.4	29.8%
60°-80°	8787.4	22.5%
80°-90°	518.0	1.3%
Back Light		
0°-30°	2971.1	7.6%
30°-60°	8241.1	21.1%
60°-80°	3333.1	8.5%
80°-90°	101.3	0.3%
Up Light		
90°-100°	0.0	0.0%
100°-180°	0.0	0.0%
Total	39075.3	100.0%
BUG Rating	B4-U0-G4	

PHOTOMETRIC SPECIFICATIONS KT-ALED290PS-L2-OSA-NM-8CSB-VDIM-X (TYPE V [5])

ISOCANDELA PLOT

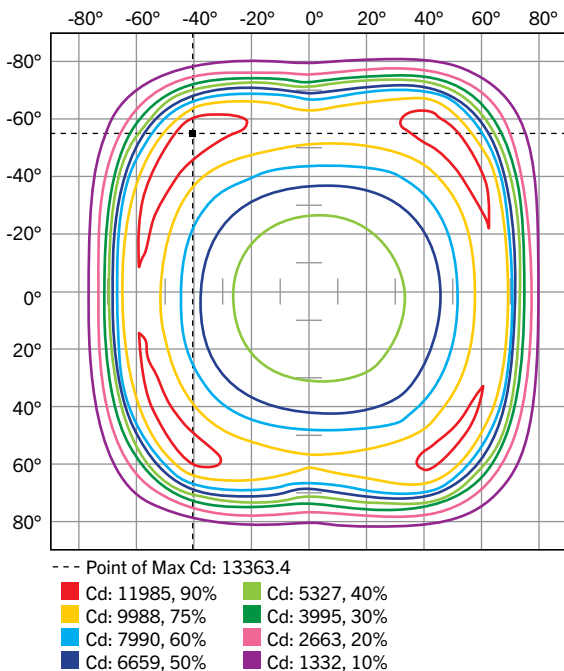

POLAR CANDELA DISTRIBUTION

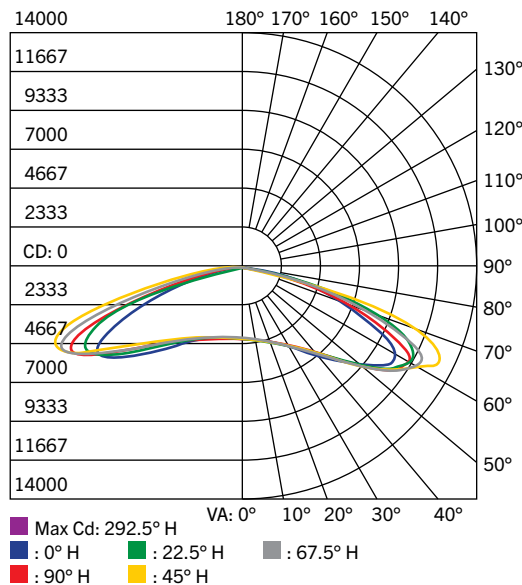

FLUX DISTRIBUTION

Zone	Lumens	% Luminaire
Forward Light		
0°-30°	2080.9	5.3%
30°-60°	9547.3	24.1%
60°-80°	8307.2	21.0%
80°-90°	338.0	0.9%
Back Light		
0°-30°	2030.2	5.1%
30°-60°	8965.1	22.7%
60°-80°	7959.9	20.1%
80°-90°	313.0	0.8%
Up Light		
90°-100°	0.0	0.0%
100°-180°	0.0	0.0%
Total	39538.6	100.0%
BUG Rating	B5-U0-G4	



KT-ALEDXXXPS-X2-OSA-NM-8CSB-VDIM-X

LED AREA LIGHT FIXTURE

EPA SPECIFICATIONS

MEDIUM AND LARGE-SIZE FIXTURE HOUSING

- Conditions: Horizontal winds only for calculations. Worst case total projected area used for calculations.
- All drag coefficients are set as worst case 1.2
- For details on exact EPA calculations and assumptions, please contact productsupport@keystonetech.com

EPA Calcs (1.2*ft^2 View)		Single Fixture	2 Fixtures at 90°	2 Fixtures at 180°	3 Fixtures at 90°	3 Fixtures at 120°	4 Fixtures at 90°	2 Fixtures Side-by-Side	3 Fixtures Side-by-Side	4 Fixtures Side-by-Side
Mounting Application	Fixture Position (Size)									
Adjustable Pole Mount 	Horizontal (M)	0.50 sq. ft.	0.78 sq. ft.	1.01 sq. ft.	1.19 sq. ft.	1.28 sq. ft.	1.19 sq. ft.	0.74 sq. ft.	1.11 sq. ft.	1.48 sq. ft.
	Horizontal (L)	0.62 sq. ft.	0.90 sq. ft.	1.24 sq. ft.	1.42 sq. ft.	1.48 sq. ft.	1.42 sq. ft.	0.74 sq. ft.	1.11 sq. ft.	1.48 sq. ft.
Adjustable Pole Mount 	45° (M)	1.27 sq. ft.	1.73 sq. ft.	1.27 sq. ft.	2.20 sq. ft.	3.10 sq. ft.	2.20 sq. ft.	2.53 sq. ft.	3.80 sq. ft.	5.07 sq. ft.
	45° (L)	1.85 sq. ft.	2.43 sq. ft.	1.85 sq. ft.	3.01 sq. ft.	4.42 sq. ft.	3.01 sq. ft.	3.70 sq. ft.	5.55 sq. ft.	7.40 sq. ft.
Slip Fitter Mount 	Horizontal (M)	0.48 sq. ft.	0.87 sq. ft.	0.97 sq. ft.	1.30 sq. ft.	1.37 sq. ft.	1.30 sq. ft.	0.86 sq. ft.	1.30 sq. ft.	1.73 sq. ft.
	Horizontal (L)	0.60 sq. ft.	0.98 sq. ft.	1.20 sq. ft.	1.53 sq. ft.	1.57 sq. ft.	1.53 sq. ft.	0.86 sq. ft.	1.30 sq. ft.	1.73 sq. ft.
Slip Fitter Mount 	45° (M)	1.34 sq. ft.	1.80 sq. ft.	1.34 sq. ft.	2.28 sq. ft.	3.06 sq. ft.	2.28 sq. ft.	2.67 sq. ft.	4.01 sq. ft.	5.35 sq. ft.
	45° (L)	1.92 sq. ft.	2.51 sq. ft.	1.92 sq. ft.	3.09 sq. ft.	4.39 sq. ft.	3.09 sq. ft.	3.84 sq. ft.	5.76 sq. ft.	7.68 sq. ft.
Slip Fitter Mount 	Vertical (M)	1.76 sq. ft.	2.25 sq. ft.	1.76 sq. ft.	2.73 sq. ft.	2.94 sq. ft.	2.73 sq. ft.	3.53 sq. ft.	5.29 sq. ft.	7.06 sq. ft.
	Vertical (L)	2.59 sq. ft.	3.19 sq. ft.	2.59 sq. ft.	3.80 sq. ft.	4.07 sq. ft.	3.80 sq. ft.	5.18 sq. ft.	7.77 sq. ft.	10.35 sq. ft.



KT-ALEDXXXPS-X2-OSA-NM-8CSB-VDIM-X

LED AREA LIGHT FIXTURE

ACCESSORIES (SOLD SEPARATELY)

SENSORS

Factory-Installable OR Field-Installable (field-installable purchased separately)

✓	SUFFIX*	CATALOG NUMBER	DESCRIPTION	UPC	EASY CODE
	/3PN	KT-TLP-UV-3PN	NEMA Type Twist-Lock 3-Pin Photocell 120-277V 1800VA Max Blue	843654131825	NQT-46
	/7PRS	KT-RSC-7PN	NEMA Type 7-Pin Receptacle	843654135205	BIZ-08
	/MW3	KTS-MW3-12V-PKO	12V Microwave Occupancy Sensor	843654130637	TRM-32
	/FC3**	KTSL-FC3-12V-PKO-PIR	Bluetooth mesh wireless screw-in LED controller for SmartLoop system Integrated daylight sensor PIR motion sensor	843654138862	OCW-60
	/FC4	KTSL-FC4-12V-PKO	Bluetooth mesh wireless screw-in low voltage fixture controller for SmartLoop system	843654149066	RUN-10



* For factory installation of accessory, add suffix to fixture part number (see ordering examples and instructions on last page of spec sheet).

** When installing on Keystone area lights, use small thin gasket provided with the sensor to ensure proper electrical connection and a water-tight seal. Hand tighten only. (Do NOT use the larger thick gasket. Sensor will not make electrical contact with thick gasket.) PIR sensors may not always perform reliably in typical outdoor environments. Ensure sensors are used and commissioned with this in mind. Consult Keystone for further information on the matter. When using KTSL-FC3-12V-PKO-PIR in applications with photosensor control for dusk to dawn, use 3-pin twist-lock photocells (KT-TLP-UV-3P) for optimal functionality.

Field-Installable / Field-Use ONLY (purchased separately)

CATALOG NUMBER	DESCRIPTION	UPC	EASY CODE
KTS-MW3-REMOTECONTROL	Remote control for KTS-MW3-12V-XX Sensors Sets and adjusts all sensor performance parameters	843654132020	XSR-61



LENSES

Field-Installable / Field-Use ONLY (purchased separately)

CATALOG NUMBER	DESCRIPTION	UPC	EASY CODE
KT-ALED-LENS-M2-2CS-KIT	Type II optics lens Used on Series 2 area lights Medium size Color Select	843654153933	ICD-51
KT-ALED-LENS-M2-4CS-KIT	Type IV optics lens Used on Series 2 area lights Medium size Color Select	843654153971	DZD-72
KT-ALED-LENS-L2-2CS-KIT	Type II optics lens Used on Series 2 area lights Large size Color Select	843654153858	HXC-12
KT-ALED-LENS-L2-4CS-KIT	Type IV optics lens Used on Series 2 area lights Large size Color Select	843654153896	CIW-62



(Accessories continued on next page)



KT-ALEDXXXPS-X2-OSA-NM-8CSB-VDIM-X

LED AREA LIGHT FIXTURE

ACCESSORIES (SOLD SEPARATELY)

MOUNTS AND BRACKETS

Field-Installable / Field-Use ONLY (purchased separately)

CATALOG NUMBER	DESCRIPTION	UPC	EASY CODE
KT-ALED-SF-1-KIT-B	Slipfitter mount Fits 2 3/8" tenon Black	843654157696	NDX-25
KT-ALED-PMA-1-KIT-B	Adjustable pole mount For round or square pole Black	843654157672	BIM-83
KT-ALED-SF-1-KIT-S	Slipfitter mount Fits 2 3/8" tenon Silver	843654157702	ZLW-27
KT-ALED-PMA-1-KIT-S	Adjustable pole mount For round or square pole Silver	843654157689	ZXM-10

Adjustable Pole Mount
KT-ALED-PMA-1-KIT-B



Adjustable Pole Mount
KT-ALED-PMA-1-KIT-S



Slip Fitter Mount
KT-ALED-SF-1-KIT-B

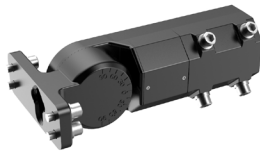

Slip Fitter Mount
KT-ALED-SF-1-KIT-S

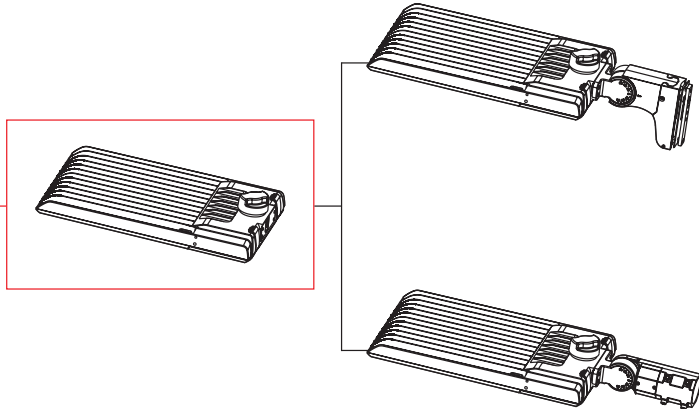
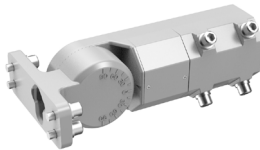



KT-ALEDXXXPS-X2-OSA-NM-8CSB-VDIM-X

LED AREA LIGHT FIXTURE

ORDERING INFORMATION

ORDER CODE	UPC	Easy Code	DLC PRODUCT ID
KT-ALED140PS-M2-OSA-NM-8CSB-VDIM-B	843654157634	FBL-20	S-QPTG52
KT-ALED140PS-M2-OSA-NM-8CSB-VDIM-S	843654157641	EXX-12	
KT-ALED290PS-L2-OSA-NM-8CSB-VDIM-B	843654157658	PBA-37	S-HRJG30
KT-ALED290PS-L2-OSA-NM-8CSB-VDIM-S	843654157665	FOM-05	

CATALOG NUMBER BREAKDOWN

KT-ALEDXXXPS-X2-OSA-NM-8CSB-VDIM-X

1	2	3	4	5	6	7	8	9	10	11	12	13	14															
1 Keystone Technologies	2 Area Light	3 LED Technology	4 Max Wattage	5 Power Select	6 Size / Shape	7 Optic Swap	8 Optic Swap Designation	9 No Mounting	9 Optic Swap Designation	10 80 CRI	12 Color Select Designation	13 0-10V Dimming	14 Housing Color															
			<table border="1" style="font-size: small;"> <tr><td>140</td><td>140W</td></tr> <tr><td>290</td><td>290W</td></tr> </table>	140	140W	290	290W		<table border="1" style="font-size: small;"> <tr><td>M</td><td>Medium</td></tr> <tr><td>L</td><td>Large</td></tr> </table>	M	Medium	L	Large			<table border="1" style="font-size: small;"> <tr><td>B</td><td>Type III lens installed, V lens included</td></tr> </table>	B	Type III lens installed, V lens included		<table border="1" style="font-size: small;"> <tr><td>B</td><td>3000/4000/5000K</td></tr> </table>	B	3000/4000/5000K		<table border="1" style="font-size: small;"> <tr><td>B</td><td>Black</td></tr> <tr><td>S</td><td>Silver</td></tr> </table>	B	Black	S	Silver
140	140W																											
290	290W																											
M	Medium																											
L	Large																											
B	Type III lens installed, V lens included																											
B	3000/4000/5000K																											
B	Black																											
S	Silver																											

ORDERING EXAMPLES

FIXTURE WITH SINGLE FACTORY-INSTALLED ACCESSORY

KT-ALED140PS-M2-OSA-NM-8CSB-VDIM-B /7PRS

FIXTURE WITH NO FACTORY-INSTALLED ACCESSORIES

KT-ALED140PS-M2-OSA-NM-8CSB-VDIM-B

KEYSTONE FIXTURE	
CATALOG NUMBER	
KT-ALED140PS-M2-OSA-NM-8CSB-VDIM-B	
SENSORS	
SUFFIX	CATALOG NUMBER
✓ /7PRS	KT-RSC-7PN

* When ordering more than one factory-installed accessory, use multiple suffixes as shown in the ordering examples above.
Note: All accessories can also be ordered separately for field installation using just their regular Catalog Number, UPC, or Easy Code.