

CONSTANT VOLTAGE KEY PROGRAMMABLE LED DRIVER CASE: XWV METAL SIDE LEAD



GENERAL INFORMATION

LED Drive Type	Key Programmable Constant Voltage, Class 2
Input Voltage	120-277 (+/-10%)
Input Frequency	50/60Hz
Programming Method	V-LOC Keys
Dimming Control	0-10V, TOUCH Dimmer*
Dimming Range	Dims to Off
Power Factor @ Full Load	>0.95%
Efficiency @ Full Load	Up to 90%
Start-Up Time	<500ms**
Line Regulation	<3%
Load Regulation (Max Load)	<3%
Output Overload Protection	Yes, Latch Mode***
Output Short-Circuit Protection	Yes, Latch Mode***
Over Temperature Protection	Yes, Latch Mode***
EMI Compliance	FCC Part 15 Class B

* TOUCH Dimmer sold separately

** Complies with ENERGY STAR[®] and CA Title 24 Specifications

*** Power cycle required

ENVIRONMENTAL SPECIFICATIONS

Minimum Operating Temp.	-30°C
Maximum Case Temp.	77.5°C
Maximum Storage Temp.	70°C
Maximum Relative Humidity	85% non-condensing
Transient Protection	NEMA SSL1-2010 Non-Roadway 2.5kV
UL Environment Rating	Dry & Damp
Sound Rating	Class A

APPROVALS



ICES-005 (B)/NMB 005 (B)

WARRANTY

- 5 year limited warranty

ELECTRICAL SPECIFICATIONS

Max. Power (W)	Output Voltage (VDC)	Output Current (A)	THD @ Full Load (120/277V)	Input Current (A)(120/277V)	Part Number
40W	12 - 48	3.3 - 0.833	<10%/<20%	0.41/0.19	XWV40-1248Z-UNV-I
60W	12 - 48	5.0 - 1.25	<10%/<20%	0.74/0.31	XWV60-1248Z-UNV-I
96W	24 - 48	4.0 - 2	<10%/<20%	1.1/0.46	XWV96-2448Z-UNV-I

Designed for LED Loads Only

SIZING INFORMATION

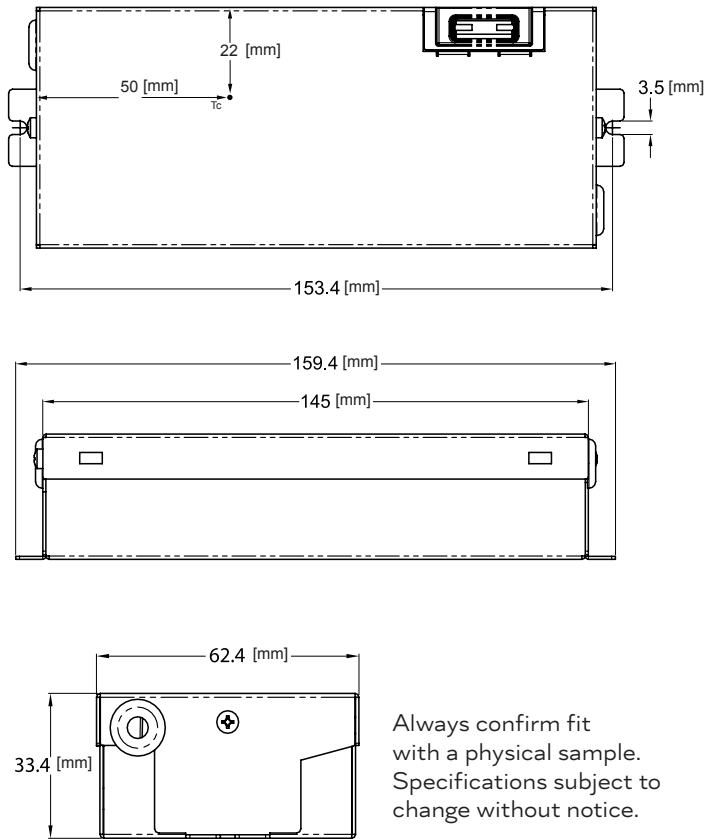

WIRING INFORMATION

Input	6" # 18AWG Black (L), White (N), Green (G)
Output	6" # 18AWG Red (+), Black/White (-)
Dimming	6" # 24AWG Purple (+), Pink (-)

PACKAGING INFORMATION

Weight	0.57 lbs
Quantity	30 pc/carton

TOUCH DIMMER

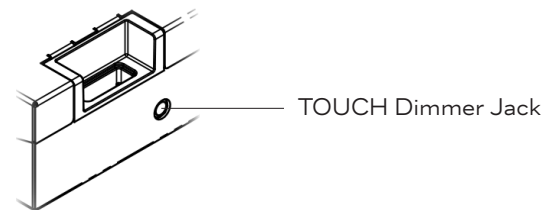

KEY SELECTOR GUIDE

Hatch V-LOC Technology enables quick and easy setting of driver output voltage with the simple click of a key. Select the appropriate V-LOC key for the desired output voltage and click it into the driver. The keys are **interchangeable** across the Hatch V-LOC constant voltage LED Driver product family.

Key Part Number	Output Voltage	Max lout (A)		
		XWV40-1248-UNV-I	XWV60-1248-UNV-I	XWV96-2448-UNV-I
X12V	12V	3.33	5	
X24V	24V	1.67	2.5	4
X36V	36V	1.11	1.67	2.67
X48V	48V	0.833	1.25	2

(Keys are marked with output voltage)

Contact Hatch for custom key values.



OUTPUT POWER - 40W

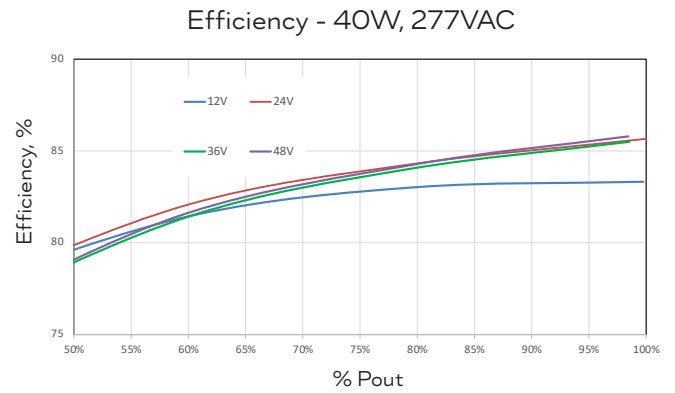
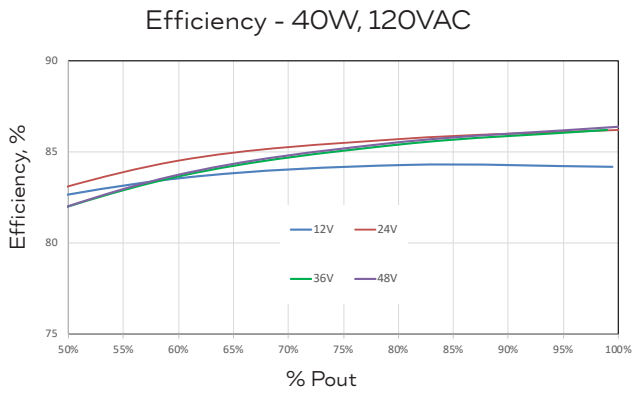
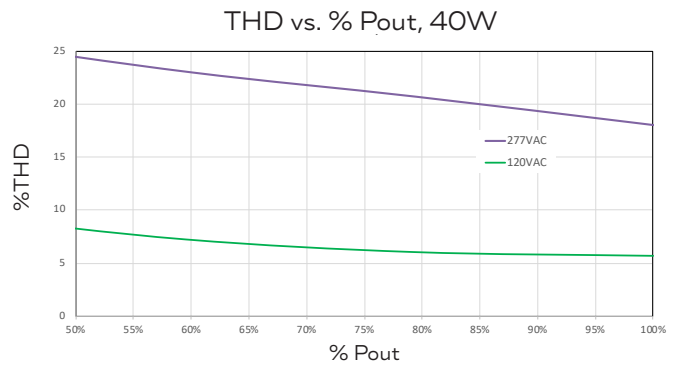
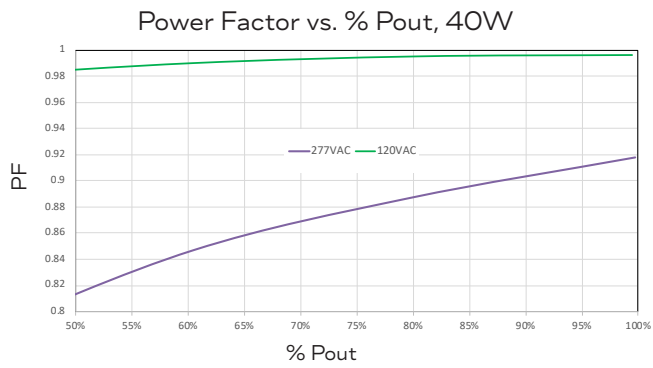

%Pout normalized for dimming level.

OUTPUT POWER - 60W

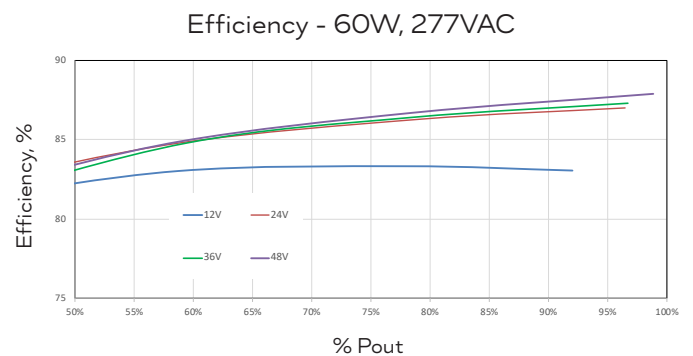
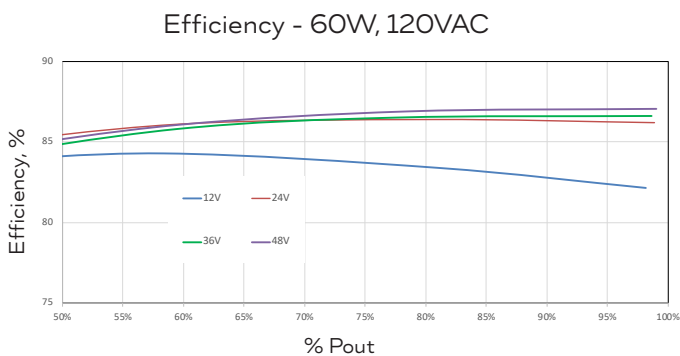
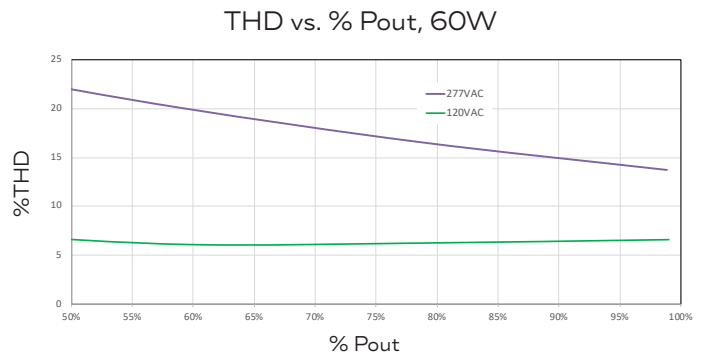
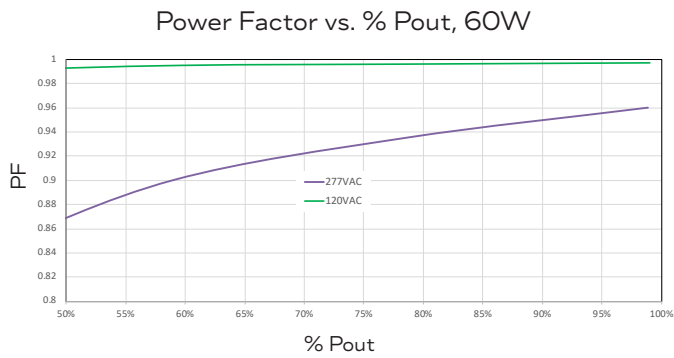

%Pout normalized for dimming level.

OUTPUT POWER - 96W

Power Factor vs. % Pout, 96W

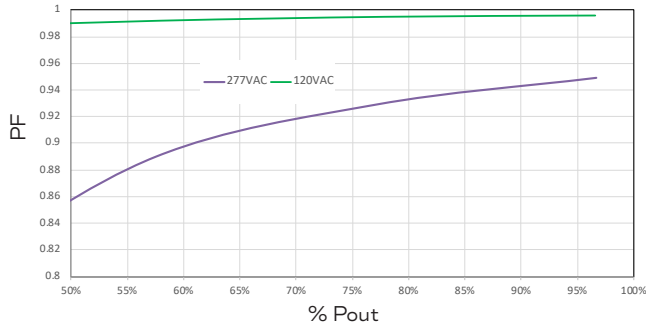

THD vs. % Pout, 96W

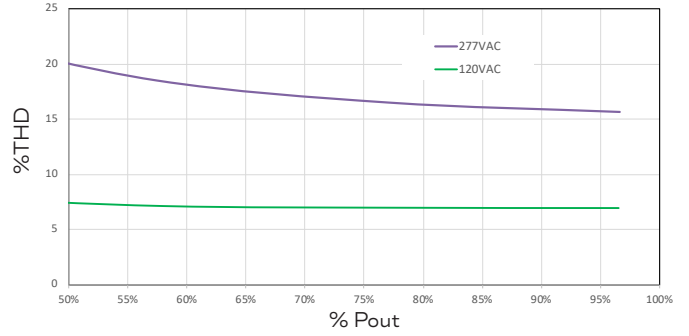

Efficiency - 96W, 120VAC

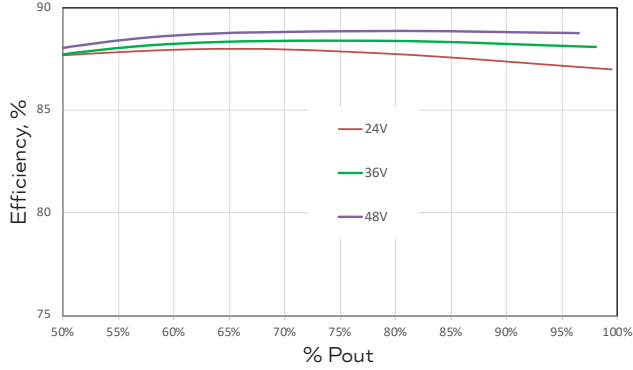

Efficiency - 96W, 277VAC

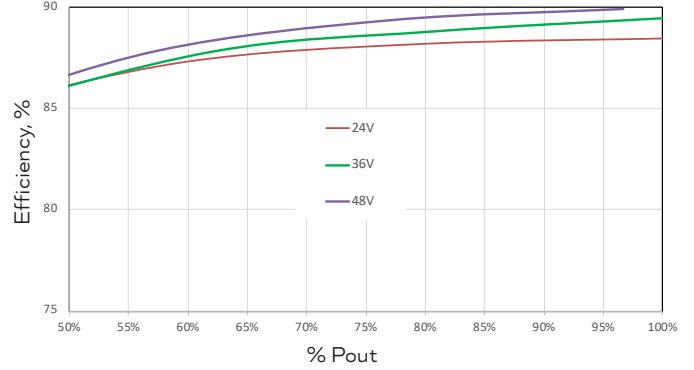

%Pout normalized for dimming level.

LIFETIME CURVE

Lifetime Vs. Tc case Temp

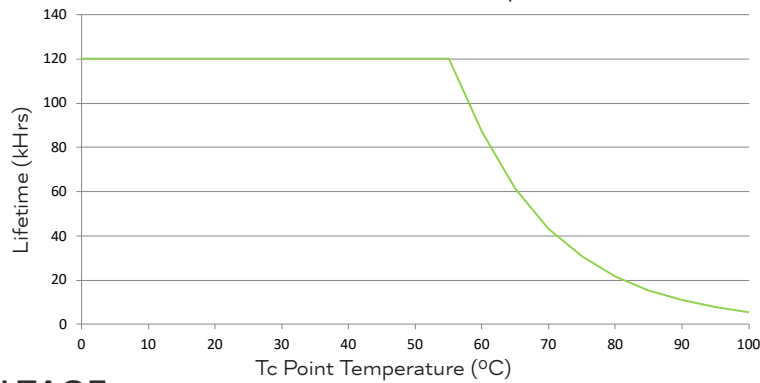

O-10V DIMMING VOLTAGE

V-LOC Dimming

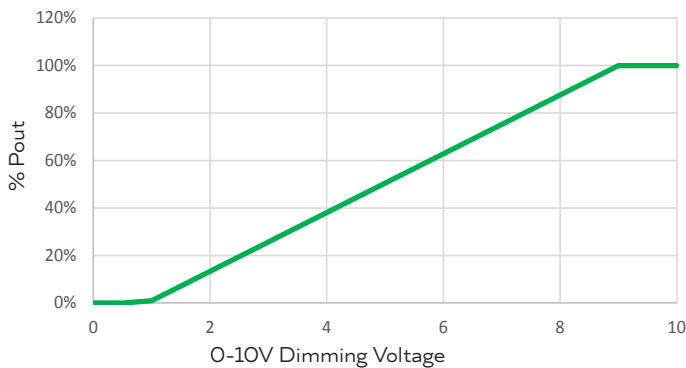

V-LOC Dim-to-Off

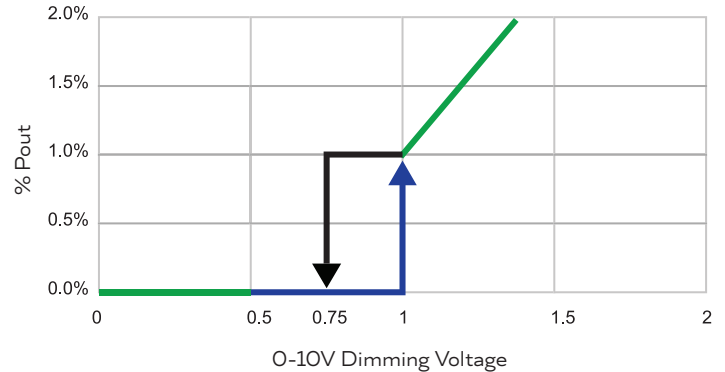

PART NUMBER GUIDE

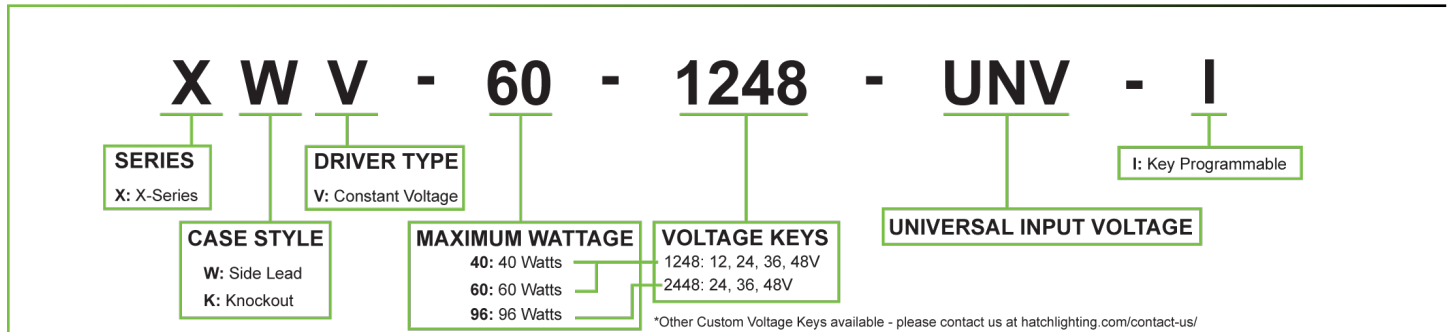

hatchlighting.com
7821 Woodland Center Blvd. Tampa, FL 33614
PH: (813) 288-8006 | FX: (813) 288-8105
sales@hatchlighting.com

12-06-2022



PRECISION POWER. PERFECT LIGHT.