

LED Magnus™ Track Fixture



Features

- Modern diecast aluminum fixture.
- Integrated driver.
- 180° vertical adjustment, 358° rotation.
- 50,000 hours life-span.
- Use with ELCO 120V Single or Double Circuit Track.
- This track head comes standard as H Style.
J (Juno) and L (Lightolier) styles are available:
For J style please order PJTHI (W/B) with the track head.

For L style please order PLTHI (W/B) with the track head.

Note these must be factory installed.

Specifications

| | |
|--------------------|------------------|
| Wattage | 15W |
| Lumens | 850 lm - 1100 lm |
| Voltage | 120V |
| Color Temp. | 3000K - SunsetK |
| Dimmable | Triac |
| Lamp Type | LED |
| Beam Angle | 15° - 60° |
| CRI | 90+ |

Options



White



Black

Technical Details

Construction: Full diecast construction for exceptional heat management and lasting quality. Powder coat architectural white and architectural black matte finishes.

Adjustability: Track head is adjustable 180° vertically with 358° rotation.

Optics: Lens provides smooth lumen output at 15°, 25°, 38° or 60°.

Installation: Effortlessly installed into H-Style track from ELCO or others. Compatible with Single and Double circuit track. Can be special ordered as J-Style (requires PJTLO W/B/) or L-Style (requires PLTLO W/B/).

LED Technology:

- Extremely accurate Color Rendering Index of 93+ CRI
- Lumen Maintenance of 50,000 hours L70 Life based on LM80 standardized test results
- Instant On to Full Brightness technology
- Chip on Board LED design results in a smooth lumen output with no LED pixelation

Sunset: Sunset color temperature is our dim-to-warm LED technology that allows the color temperature to become warmer as the product is dimmed. Our SUNSET items start at 3000K and go as low as 1800K when dimmed. For Sunset dim technology be sure to order an item with "Sunset" in the Color Temperature (CCT) attribute.

Dimmability:

- Triac dimmable down to 10%
- Flicker-Free Dimming
- For full list of dimmers refer to the Dimmer Compatibility List

Electrical:

- Driver is rated for 120V input
- High Efficiency driver with a power factor > 0.9

Listings:

Dimensions

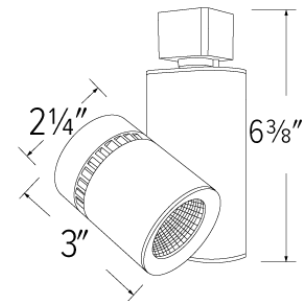

Product Numbers

| Item | Lamp type | Lumens | CCT | Watts | Voltage | Dimming | Beam Angle | Finish |
|-------------------|-----------|---------|-------|-------|---------|---------|------------|-----------|
| ET743DB | LED | 1000 lm | 3000K | 15W | 120V | Triac | 15° | All Black |
| ET744DB | LED | 1000 lm | 3000K | 15W | 120V | Triac | 25° | All Black |
| ET745DB | LED | 1000 lm | 3000K | 15W | 120V | Triac | 38° | All Black |
| ET746DB | LED | 1000 lm | 3000K | 15W | 120V | Triac | 60° | All Black |
| ET743DW | LED | 1000 lm | 3000K | 15W | 120V | Triac | 15° | All White |
| ET744DW | LED | 1000 lm | 3000K | 15W | 120V | Triac | 25° | All White |
| ET745DW | LED | 1000 lm | 3000K | 15W | 120V | Triac | 38° | All White |
| ET746DW | LED | 1000 lm | 3000K | 15W | 120V | Triac | 60° | All White |
| ET743-35DW | LED | 1050 lm | 3500K | 15W | 120V | Triac | 15° | All White |

- ETL Listed
- RoHS Compliant

Warranty: ELCO Products are built to last. 5-year Limited warranty.

| Item | Lamp type | Lumens | CCT | Watts | Voltage | Dimming | Beam Angle | Finish |
|------------|-----------|---------|---------|-------|---------|---------|------------|-----------|
| ET744-35DW | LED | 1050 lm | 3500K | 15W | 120V | Triac | 25° | All White |
| ET745-35DW | LED | 1050 lm | 3500K | 15W | 120V | Triac | 38° | All White |
| ET746-35DW | LED | 1050 lm | 3500K | 15W | 120V | Triac | 60° | All White |
| ET743-35DB | LED | 1050 lm | 3500K | 15W | 120V | Triac | 15° | All Black |
| ET744-35DB | LED | 1050 lm | 3500K | 15W | 120V | Triac | 25° | All Black |
| ET745-35DB | LED | 1050 lm | 3500K | 15W | 120V | Triac | 38° | All Black |
| ET746-35DB | LED | 1050 lm | 3500K | 15W | 120V | Triac | 60° | All Black |
| ET743-40DB | LED | 1100 lm | 4000K | 15W | 120V | Triac | 15° | All Black |
| ET743-Sddb | LED | 850 lm | SunsetK | 15W | 120V | Triac | 15° | All Black |
| ET744-Sddb | LED | 850 lm | SunsetK | 15W | 120V | Triac | 25° | All Black |
| ET745-Sddb | LED | 850 lm | SunsetK | 15W | 120V | Triac | 38° | All Black |
| ET746-Sddb | LED | 850 lm | SunsetK | 15W | 120V | Triac | 60° | All Black |
| ET743-SDDW | LED | 850 lm | SunsetK | 15W | 120V | Triac | 15° | All White |
| ET744-SDDW | LED | 850 lm | SunsetK | 15W | 120V | Triac | 25° | All White |
| ET745-SDDW | LED | 850 lm | SunsetK | 15W | 120V | Triac | 38° | All White |
| ET746-SDDW | LED | 850 lm | SunsetK | 15W | 120V | Triac | 60° | All White |

Product Number Builder Example: ET743DB

| | | | | |
|-----------------------------|----------------------|----------------------|----------------------|----------------------|
| ELCO Magnus™ Track Fixtures | Beam Spread | CCT | Dimming | Finish |
| ET74 | <input type="text"/> | <input type="text"/> | <input type="text"/> | <input type="text"/> |
| | 3 15° | 3000K | D Dimming | B All Black |
| | 4 25° | -35 3500K | | W All White |
| | 5 38° | -40 4000K | | |
| | 6 60° | | | |

Single Circuit

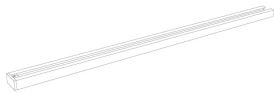

Single Circuit Track

Track supplied with dead end and mounting hardware

| CAT NO. | SPECIFICATIONS |
|---------|----------------|
| EP002W | White / 2' |
| EP004W | White / 4' |
| EP006W | White / 6' |
| EP008W | White / 8' |
| EP012W | White / 12' |
| EP002B | Black / 2' |
| EP004B | Black / 4' |
| EP006B | Black / 6' |
| EP008B | Black / 8' |
| EP0012B | Black / 12' |
| EP002BZ | Bronze / 2' |
| EP004BZ | Bronze / 4' |
| EP006BZ | Bronze / 6' |
| EP008BZ | Bronze / 8' |
| EP002N | Nickel / 2' |
| EP004N | Nickel / 4' |
| EP006N | Nickel / 6' |
| EP008N | Nickel / 8' |

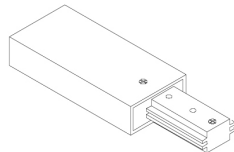

Live End Connector

Live end connector used for direct wiring

| CAT NO. | SPECIFICATIONS |
|---------|----------------|
| EP801W | White |
| EP801B | Black |
| EP801BZ | Bronze |
| EP801N | Nickel |

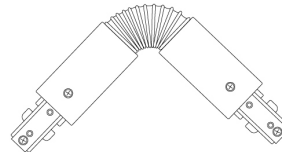

Flexible Connector

Flexible connector to join two track sections at an angle up to 90°. Can be used as a feed point

| CAT NO. | SPECIFICATIONS |
|---------|----------------|
| EP802W | White |
| EP802B | Black |
| EP802BZ | Bronze |
| EP802N | Nickel |

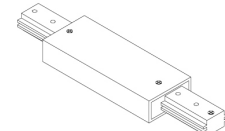

Straight Connector

Power feedable connector to join two track sections

| CAT NO. | SPECIFICATIONS |
|---------|----------------|
| EP803W | White |
| EP803B | Black |
| EP803BZ | Bronze |
| EP803N | Nickel |

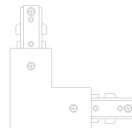

L Connector

Power feedable connector to join two track sections at a 90° angle

| CAT NO. | SPECIFICATIONS |
|---------|----------------|
| EP804W | White |
| EP804B | Black |
| EP804BZ | Bronze |
| EP804N | Nickel |

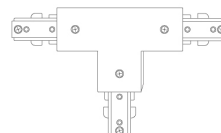

T Connector

Power feedable connector to join three track sections

| CAT NO. | SPECIFICATIONS |
|---------|----------------|
| EP805W | White |
| EP805B | Black |
| EP805BZ | Bronze |
| EP805N | Nickel |

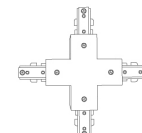

X Connector

Power feedable connector to join four track sections

| CAT NO. | SPECIFICATIONS |
|---------|----------------|
| EP806W | White |
| EP806B | Black |
| EP806BZ | Bronze |
| EP806N | Nickel |



Mini Connector

Mini Connector to join two track sections. Cannot be used as a feed point

| CAT NO. | SPECIFICATIONS |
|---------|----------------|
| EP808W | White |
| EP808B | Black |
| EP808BZ | Bronze |
| EP808N | Nickel |

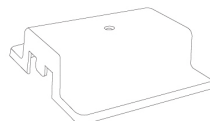

Floating Canopy

Can be used anywhere along length of track to supply power. Includes end cap

| CAT NO. | SPECIFICATIONS |
|---------|----------------|
| EP809W | White |
| EP809B | Black |
| EP809BZ | Bronze |
| EP809N | Nickel |

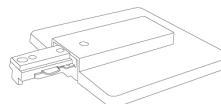

End Feed Kit

Kit includes live end feed and canopy to mount on outlet box. 4 1/2" x 4 1/2" x 1/4" thick

| CAT NO. | SPECIFICATIONS |
|---------|----------------|
| EP810W | White |
| EP810B | Black |
| EP810BZ | Bronze |
| EP810N | Nickel |

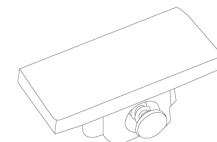

Dead End

Dead end cap for single and double circuit track

| CAT NO. | SPECIFICATIONS |
|---------|----------------|
| EP812W | White |
| EP812B | Black |
| EP812BZ | Bronze |
| EP812N | Nickel |

Single Circuit

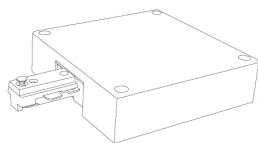

T-Bar Ceiling Feed

Live feed with outlet box for use with T-bar ceilings

| CAT NO. | SPECIFICATIONS |
|---------|----------------|
| EP817W | White |
| EP817B | Black |
| EP817BZ | Bronze |
| EP817N | Nickel |

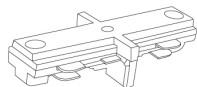

Dead Mini Connector

Dead Mini Connector to join two track sections without passing the power

| CAT NO. | SPECIFICATIONS |
|---------|----------------|
| EP825W | White |
| EP825B | Black |
| EP825BZ | Bronze |
| EP825N | Nickel |



T-Bar Ceiling Feed

In-line T-bar ceiling feed

| CAT NO. | SPECIFICATIONS |
|---------|----------------|
| EP827W | White |
| EP827B | Black |

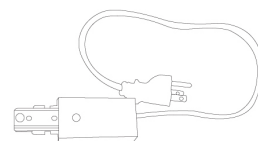

Cord and Plug Connector

Cord and Plug Connector for single circuit track. 10 Amp MAX or 1200W. 12 ft. long

| CAT NO. | SPECIFICATIONS |
|---------|----------------|
| EP850W | White |
| EP850B | Black |
| EP850BZ | Bronze |
| EP850N | Nickel |

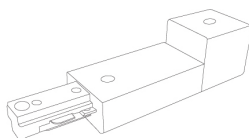

Conduit Connector

To start a surface run

| CAT NO. | SPECIFICATIONS |
|---------|----------------|
| EP880W | White |
| EP880B | Black |
| EP880BZ | Bronze |
| EP880N | Nickel |

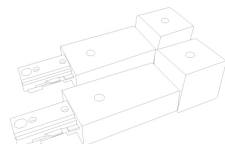

Conduit Continuation Kit

Kit includes: (1) Left and (1) Right feed, to continue around obstructions with 1/2" surface conduit

| CAT NO. | SPECIFICATIONS |
|---------|----------------|
| EP979W | White |
| EP979B | Black |

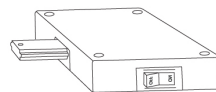

Live Feed with Current Limiter

Current Limiter for single circuit track. 1A to 12A available

| CAT NO. | SPECIFICATIONS |
|-------------|------------------|
| EP840W-1A | White \ 1 Amp |
| EP840W-2A | White \ 2.5 Amp |
| EP840W-5A | White \ 5 Amp |
| EP840W-7A | White \ 7.5 Amp |
| EP840W-10A | White \ 10 Amp |
| EP840W-12A | White \ 12 Amp |
| EP840B-1A | Black \ 1 Amp |
| EP840B-2A | Black \ 2.5 Amp |
| EP840B-5A | Black \ 5 Amp |
| EP840B-7A | Black \ 7.5 Amp |
| EP840B-10A | Black \ 10 Amp |
| EP840B-12A | Black \ 12 Amp |
| EP840BZ-1A | Bronze \ 1 Amp |
| EP840BZ-2A | Bronze \ 2.5 Amp |
| EP840BZ-5A | Bronze \ 5 Amp |
| EP840BZ-7A | Bronze \ 7.5 Amp |
| EP840BZ-10A | Bronze \ 10 Amp |
| EP840BZ-12A | Bronze \ 12 Amp |



In-Line Feed Connector with Current Limiter

Current Limiter for single circuit track. 1A to 12A available

| CAT NO. | SPECIFICATIONS |
|------------|-----------------|
| EP841W-1A | White \ 1 Amp |
| EP841W-2A | White \ 2.5 Amp |
| EP841W-5A | White \ 5 Amp |
| EP841W-7A | White \ 7.5 Amp |
| EP841W-10A | White \ 10 Amp |
| EP841W-12A | White \ 12 Amp |
| EP841B-1A | Black \ 1 Amp |
| EP841B-2A | Black \ 2.5 Amp |
| EP841B-5A | Black \ 5 Amp |
| EP841B-7A | Black \ 7.5 Amp |
| EP841B-10A | Black \ 10 Amp |
| EP841B-12A | Black \ 12 Amp |

Two Circuit



Two Circuit Track

Track supplied with dead end and mounting hardware

| CAT NO. | SPECIFICATIONS |
|---------|----------------|
| EC002W | White / 2' |
| EC004W | White / 4' |
| EC006W | White / 6' |
| EC008W | White / 8' |
| EC012W | White / 12' |
| EC002B | Black / 2' |
| EC004B | Black / 4' |
| EC006B | Black / 6' |
| EC008B | Black / 8' |
| EC012B | Black / 12' |

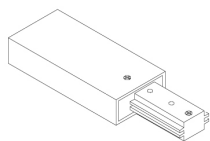

Live End Connector

Two circuit live end connector to start a run

| CAT NO. | SPECIFICATIONS |
|---------|----------------|
| EC801W | White |
| EC801B | Black |

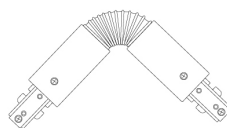

Flexible Connector

Flexible connector to join two track sections at an angle up to 90°

| CAT NO. | SPECIFICATIONS |
|---------|----------------|
| EC802W | White |
| EC802B | Black |

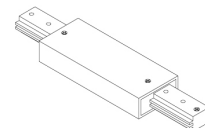

Straight Connector

Power feedable connector to join two track sections

| CAT NO. | SPECIFICATIONS |
|---------|----------------|
| EC803W | White |
| EC803B | Black |

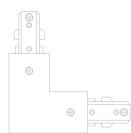

L Connector

Power feedable connector to join two track sections at a 90° angle

| CAT NO. | SPECIFICATIONS |
|---------|----------------|
| EC804W | White |
| EC804B | Black |

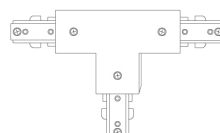

T Connector

Power feedable connector to join three track sections

| CAT NO. | SPECIFICATIONS |
|---------|----------------|
| EC805W | White |
| EC805B | Black |

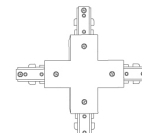

X Connector

Power feedable connector to join four track sections

| CAT NO. | SPECIFICATIONS |
|---------|----------------|
| EC806W | White |
| EC806B | Black |



Mini Connector

Mini Connector to join two track sections. Cannot be used as a feed point

| CAT NO. | SPECIFICATIONS |
|---------|----------------|
| EC808W | White |
| EC808B | Black |



Floating Canopy

Can be used anywhere along length of track to supply power. Includes end cap

| CAT NO. | SPECIFICATIONS |
|---------|----------------|
| EC809W | White |
| EC809B | Black |

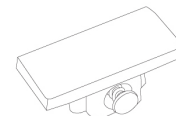

Dead End

Dead end cap for single and double circuit track

| CAT NO. | SPECIFICATIONS |
|---------|----------------|
| EP812W | White |
| EP812B | Black |

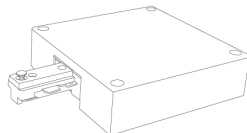

T-Bar Ceiling Feed

Live feed with outlet box for use with T-bar ceilings

| CAT NO. | SPECIFICATIONS |
|---------|----------------|
| EC817W | White |
| EC817B | Black |

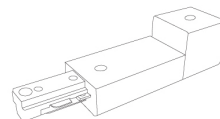

Conduit Connector

To start a surface run

| CAT NO. | SPECIFICATIONS |
|---------|----------------|
| EC880W | White |
| EC880B | Black |

Two Circuit

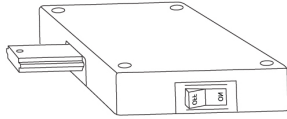

**Two Circuit Live-End Feed Connector
with Current Limiter**

1A to 12A available. Separate circuit breaker for each circuit.
Custom current rating available upon request

| CAT NO. | SPECIFICATIONS | CIRCUIT 1 | | CIRCUIT 2 | |
|---------|----------------|-----------|----------|-----------|----------|
| EC840W | White | 1A | 1 Amp | 1A | 1 Amp |
| EC840B | Black | 2A | 2.5 Amp | 2A | 2.5 Amp |
| | | 5A | 5 Amp | 5A | 5 Amp |
| | | 7A | 7.5 Amp | 7A | 7.5 Amp |
| | | 10A | 10 Amp | 10A | 10 Amp |
| | | 12A | 12.5 Amp | 12A | 12.5 Amp |

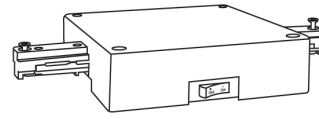

**Two Circuit In-Line Feed Connector
with Current Limiter**

1A to 12A available. Separate circuit breaker for each circuit.
Custom current rating available upon request

| CAT NO. | SPECIFICATIONS | CIRCUIT 1 | | CIRCUIT 2 | |
|---------|----------------|-----------|----------|-----------|----------|
| EC841W | White | 1A | 1 Amp | 1A | 1 Amp |
| EC841B | Black | 2A | 2.5 Amp | 2A | 2.5 Amp |
| | | 5A | 5 Amp | 5A | 5 Amp |
| | | 7A | 7.5 Amp | 7A | 7.5 Amp |
| | | 10A | 10 Amp | 10A | 10 Amp |
| | | 12A | 12.5 Amp | 12A | 12.5 Amp |

General

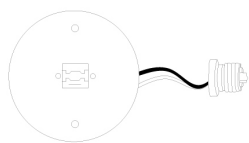

Track Adapter Trim

For use with standard 6" recessed housings. Allow track lamp holders to be used with recessed installations. Up to 150W Max. 7 1/2" O.D.

| CAT NO. | SPECIFICATIONS |
|---------|----------------|
| EP577W | White |
| EP577B | Black |

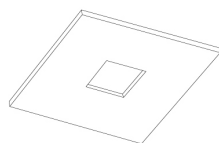

Outlet Box Cover

Outlet box cover. Screws not included. 5" x 5" x 1/8" x 1 1/4" Sq

| CAT NO. | SPECIFICATIONS |
|---------|----------------|
| EP800W | White |
| EP800B | Black |
| EP800BZ | Bronze |

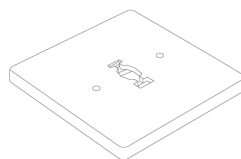

Monopoint Canopy

Allows any lamp holder (300W MAX.) to be converted to canopy installation. For Line Voltage fixtures

| CAT NO. | SPECIFICATIONS |
|---------|----------------|
| EP811W | White |
| EP811B | Black |
| EP811BZ | Bronze |
| EP811N | Nickel |



Sign Hanger

Sign Hanger with hook for single and double circuit track. Holds up to 25 lbs

| CAT NO. | SPECIFICATIONS |
|---------|----------------|
| EP813W | White |
| EP813B | Black |
| EP813BZ | Bronze |
| EP813N | Nickel |

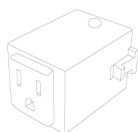

Outlet Adapter

Outlet Adapter for single circuit and two circuit track

| CAT NO. | SPECIFICATIONS |
|---------|----------------|
| EP814W | White |
| EP814B | Black |
| EP814BZ | Bronze |
| EP814N | Nickel |



Pendant Adapter

For single circuit and two circuit track with strain relief connector for cord or chain hung fixtures. Holds up to 35 lbs

| CAT NO. | SPECIFICATIONS |
|---------|----------------|
| EP815W | White |
| EP815B | Black |
| EP815BZ | Bronze |
| EP815N | Nickel |



Round Monopoint Canopy

For Line Voltage fixtures. 4 5/8" O.D.

| CAT NO. | SPECIFICATIONS |
|---------|----------------|
| EP819W | White |
| EP819B | Black |
| EP819BZ | Bronze |

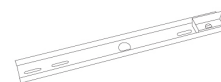

Straight Channel

Provides support for straight connection points in suspended track system. Track sits inside the channel. 16 1/4" long. Support rails for tracks

| CAT NO. | SPECIFICATIONS |
|---------|----------------|
| EP844W | White |
| EP844B | Black |

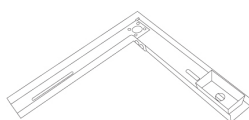

L Channel

Support corner connection points in suspended track system. Track sits inside the channel. 16 1/4" long in each side. Support rails for tracks

| CAT NO. | SPECIFICATIONS |
|---------|----------------|
| EP845W | White |
| EP845B | Black |

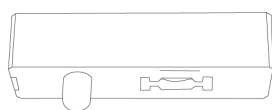

Dimmer Switch

Dimmer with ON/OFF switch. For Line Voltage fixtures. 150W MAX. For use with extension wands. Halogen lamps only

| CAT NO. | SPECIFICATIONS |
|---------|----------------|
| EP901W | White |
| EP901B | Black |



Clamp Cord and Plug

Clamp with 6 ft. cord and plug with female track connector for attaching a Line Voltage fixture

| CAT NO. | SPECIFICATIONS |
|---------|----------------|
| EP903W | White |
| EP903B | Black |



48" Steel Stem

For additional pendant length. Includes coupling. Use with EP918, EP924, EP936, and EP948

| CAT NO. | SPECIFICATIONS |
|---------|----------------|
| EP904W | White |
| EP904B | Black |

General



T-Bar Attachment Clip

Allows track to be attached to inverted T-Bar ceiling. Order as follow: (2) clips for 2' or 4' track, (3) clips for 6' track, (4) clips for 8' or 12' track

| CAT NO. | SPECIFICATIONS |
|---------|----------------|
| EP989B | Black |

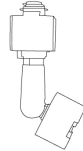

Slope Ceiling Fixture Adapter

Allows use of extension wands on slope ceiling. 0°- 90°

| CAT NO. | SPECIFICATIONS |
|---------|----------------|
| EP906W | White |
| EP906B | Black |

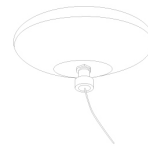

Track Pendant Kit

Track pendant kit with 60" stainless steel cable. 1/16" stranded

| CAT NO. | SPECIFICATIONS |
|---------|----------------|
| EP960W | White |
| EP960B | Black |

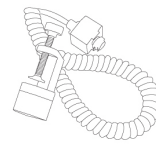

Clamp Cord and Track Adapter

Connects to Line Voltage track. Includes female track connector for attaching a Line Voltage fixture

| CAT NO. | SPECIFICATIONS |
|---------|----------------|
| EP907W | White |
| EP907B | Black |

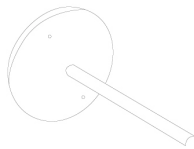

Pendant Assembly

Suspends track from ceiling. Order as follow: (2) kits for 2' or 4' track, (3) kits for 6' track, (4) kits for 8' track, (5) kits for 12', (1) EP807 per feed

| CAT NO. | SPECIFICATIONS |
|---------|----------------|
| EP918W | White \ 18" |
| EP924W | White \ 24" |
| EP936W | White \ 36" |
| EP948W | White \ 48" |
| EP918B | Black \ 18" |
| EP924B | Black \ 24" |
| EP936B | Black \ 36" |
| EP948B | Black \ 48" |



Sloped Ceiling Pendant Adapter

Sloped Ceiling Pendant adapter for use with EP918, EP924, EP936, and EP948

| CAT NO. | SPECIFICATIONS |
|---------|----------------|
| EP905W | White |
| EP905B | Black |

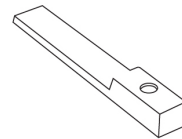

Wire Cover

Wire cover for power feed through with pendant assembly. One per run. For use with EP918 to EP948

| CAT NO. | SPECIFICATIONS |
|---------|----------------|
| EP807W | White |
| EP807B | Black |
| EP807BZ | Bronze |
| EP807N | Nickel |

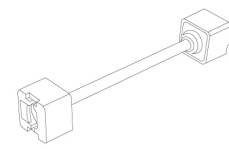

Extension Wand

Line voltage extension wands. Drops head from track

| CAT NO. | SPECIFICATIONS |
|---------|----------------|
| EP881W | 6" |
| EP882W | 12" |
| EP818W | 18" |
| EP824W | 24" |
| EP836W | 36" |
| EP848W | 48" |
| EP881B | 6" |
| EP882B | 12" |
| EP818B | 18" |
| EP824B | 24" |
| EP836B | 36" |
| EP848B | 48" |

LED Track Fixture

PHOTOMETRIC REPORT

Product #: ET743D
 Wattage/Lumens: 15.6W/ 937 Lm
 Luminaire LPW: 60 Lm/W

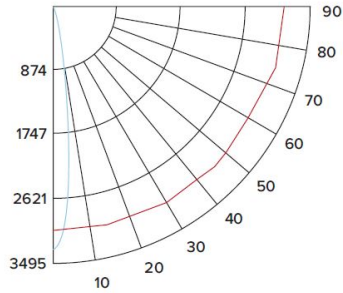

CANDLE POWER SUMMARY

| Degrees Vertical | 0° |
|------------------|------|
| 0 | 3401 |
| 5 | 2494 |
| 15 | 673 |
| 25 | 423 |
| 35 | 321 |
| 45 | 86 |
| 55 | 12 |
| 65 | 8 |
| 75 | 6 |
| 85 | 2 |
| 90 | 1 |

ILLUMINANCE AT A DISTANCE

| Distance to Target Plane | Footcandles Beam Center | Beam Diameter |
|--------------------------|-------------------------|---------------|
| 4' | 213 | 1.2' |
| 6' | 94.5 | 1.9' |
| 8' | 53.1 | 2.5' |
| 10' | 34.0 | 3.1' |

ZONAL LUMEN SUMMARY

| Zone | Lumens | % Luminaire |
|-------|--------|-------------|
| 0-30° | 632.58 | 67.50 |
| 0-40° | 829.31 | 88.50 |
| 0-60° | 922.34 | 98.40 |
| 0-90° | 937.05 | 100.00 |

LED Track Fixture

PHOTOMETRIC REPORT

Product #: ET744D
 Wattage/Lumens: 15.6W/ 940 Lm
 Luminaire LPW: 60 Lm/W

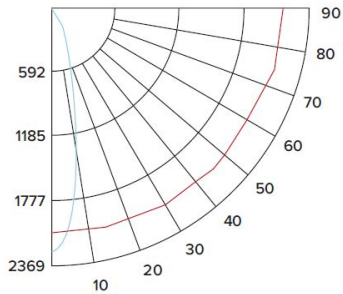

CANDLE POWER SUMMARY

| Degrees Vertical | 0° |
|------------------|------|
| 0 | 2306 |
| 5 | 1983 |
| 15 | 794 |
| 25 | 423 |
| 35 | 319 |
| 45 | 94 |
| 55 | 14 |
| 65 | 8 |
| 75 | 7 |
| 85 | 2 |
| 90 | 1 |

ILLUMINANCE AT A DISTANCE

| Distance to Target Plane | Footcandles Beam Center | Beam Diameter |
|--------------------------|-------------------------|---------------|
| 4' | 144 | 1.8' |
| 6' | 64.0 | 2.7' |
| 8' | 36.0 | 3.6' |
| 10' | 23.1 | 4.4' |

ZONAL LUMEN SUMMARY

| Zone | Lumens | % Luminaire |
|-------|--------|-------------|
| 0-30° | 631.98 | 67.30 |
| 0-40° | 828.41 | 88.20 |
| 0-60° | 925.26 | 98.50 |
| 0-90° | 939.69 | 100.00 |



ELCO Lighting

Dimmer Compatibility Chart

ETW4030&4040, ETW4130&4140

ET743D-746D

For Reference Only

Testing conducted by ELCO Lighting is not a substitute for and does not imply certification by an independent laboratory or any other standards certification. Refer to manufacturer specifications for more detailed information on product certifications and standards. Consult the dimmer manufacturer prior to installation to ensure compatibility.

| Manufacturer | Product | Part Number | Dimmed Light Output Range |
|--------------|---|-------------|---------------------------|
| Cooper | DEVINE Decorator Single Pole/3-Way Preset Dimmer | DLC03P | 10% - 100% |
| | SKYE Slide Single Pole/3-Way Preset Dimmer | SLC03P | 10% - 100% |
| | AL Series Decorator Single Pole/3-Way Preset Dimmer | DAL06P | 10% - 100% |
| Lightolier | Sunrise 3-Way Preset Electronic Low Voltage Dimmer | ZP260QEW | 8% - 100% |
| Lutron | Skylark® Contour Single Pole/3-Way Dimmer | CT-103P | 8% - 100% |
| | Diva® Single Pole Incandescent/Halogen Preset Dimmer | DV-600P | 10% - 100% |
| | Diva® C•L Single Pole/3-Way Dimmer | DVCL-153P | 7% - 100% |
| | Diva® 3-Way Electronic Low Voltage Dimmer | DVELV-303P | 8% - 100% |
| | Lumea® Single Pole Incandescent/Halogen Preset Dimmer | LG-600P | 10% - 100% |
| | Maestro® Single Pole/Multi-Location Electronic Low Voltage Dimmer | MAELV-600 | 8% - 100% |
| | Skylark® Single Pole Incandescent/Halogen Slide-to-Off Dimmer | S-600P | 10% - 100% |
| | Skylark® Single Pole/3-Way Incandescent/Halogen Preset "Eco-Dim" Dimmer | S-603PG | 5% - 85% |
| | Skylark® Single Pole Electronic Low Voltage Preset Dimmer | SELV-300P | 8% - 100% |
| | Toggler® Single Pole Incandescent Dimmer | TG-600P | 10% - 100% |
| | Toggler® C•L Single Pole/3-Way Dimmer | TGCL-153P | 7% - 100% |
| | Faetra® Single Location Digital Fade Dimmer | FAELV-500 | 8% - 100% |
| Leviton | Decora 4-Level Step Electro-Mechanical Incandescent Dimmer | 6161 | 10% - 100% |
| | SureSlide Electro-Mechanical Incandescent Dimmer | 6631-2 | 10% - 100% |
| | SureSlide 3-Way Preset Incandescent Dimmer | 6633-P | 10% - 100% |
| | Trimatron Deluxe 3-Way Push On/Off Rotary Incandescent Dimmer | 6683-IW | 10% - 100% |
| | IllumaTech Single Pole/3-Way Electronic Low Voltage Dimmer | IPE04 | 8% - 100% |
| | Illumatech Single Pole/3-Way Incandescent Dimmer | IPI06-1LZ | 10% - 100% |
| | Vizia Single Pole/3-Way Electronic Low Voltage Dimmer | VPE06 | 8% - 100% |

*NOTE: Refer to dimmer manufacturer's documentation for installation instructions and circuit details

Disclaimer: Minimum and maximum loads for LEDs and CFLs are given in number of lamps and may vary depending on the lamp being used. Testing conducted by ELCO Lighting is not a substitute for and does not imply certification by an independent laboratory or any other standards certification. Refer to manufacturer specifications for more detailed information on product certifications and standards.