

LSPW58X-RGB 5.8W Outdoor Color-Changing LED Strip

SPECIFICATION SHEET

JOB NAME: _____
LOCATION: _____
QUOTE/REF#: _____

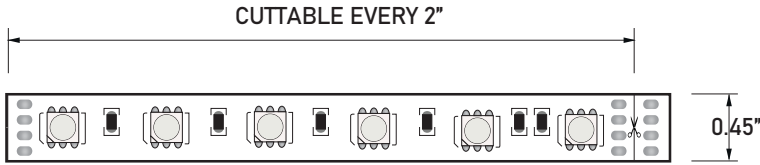

LSPW58X-RGB series is a flexible outdoor rated color-changing LED strip that provides the perfect lighting solution for spaces that require dynamic full color and white LED illumination. The warm white LED's combined with the full color spectrum of the RGB light array produces more powerful color options that's sure to please even the most discerning lighting designer. Suitable for residential, commercial and retail lighting applications.

SPECIFICATIONS

INPUT VOLTAGE	24V DC
POWER CONSUMPTION	5.8W per foot
LUMEN OUTPUT	218 lm/Ft.
NO. OF LEDs	36 LEDs per foot
BEAM ANGLE	120°
CRI	90+
DIMMING	Through RGB controller
MAXIMUM RUN LENGTH	12 feet
FIELD CUTTABLE	Every 2" (50.8MM)
IP RATING	IP65 outdoor/wet rated
LUMEN MAINTENANCE	50,000 hrs.
OPERATING TEMPERATURE	-40°F(-40°C)~+140°F(+60°C)
STORAGE TEMPERATURE	-40°F(-40°C)~+140°F(+60°C)
CERTIFICATIONS	UL listed, TITLE 24 JA8
DIMENSIONS	0.45" x 0.22" (width x height)

FEATURES

- 5.8W per Foot
- 218 Lumens
- 90 CRI
- California **TITLE 24 JA8** compliant
- Field cuttable
- Suitable for accent or ambient lighting
- Outdoor/ wet rated
- Superior COLOR RENDERING INDEX (CRI)
- Available in 24V
- UL Listed

RGB COLOR SPECTRUM

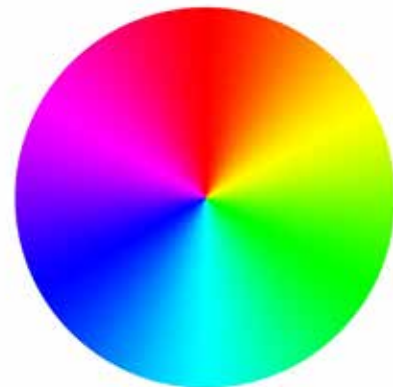

LSPW58X-RGB 5.8W Outdoor Color-Changing LED Strip

STANDARD ORDERING CODE

Model	Color Temp	Length	Voltage
LSPW58X	RGB - RGB	16 - 16 Ft. 100 - 100 Ft. PF - Per foot	24V - 24V DC

CUSTOMIZED LENGTH ORDERING CODE

Model	Color Temp	Length	Voltage	Profile
LSPW58X	RGB - RGB	XX - Custom Length	24V - 24V DC	See p3

LSPW58X-RGB 5.8W Outdoor Color-Changing LED Strip

COMPATIBLE ALUMINUM PROFILES

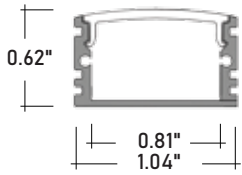

ALU-DS100 **SURFACE MOUNT**
LENGTHS 39^{3/8}" 78"
LENS Clear and Frosted
FINISH Anodized Aluminum

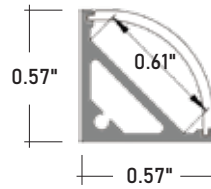

ALP-50C **SURFACE / CORNER**
LENGTHS 49.25" , 98.5"
LENS Frosted
FINISH Anodized Aluminum

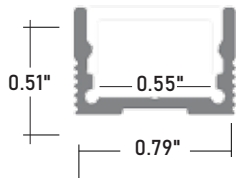

ALP-70 **SURFACE MOUNT**
LENGTHS 49.25" , 98.5"
LENS Frosted
FINISH Anodized Aluminum

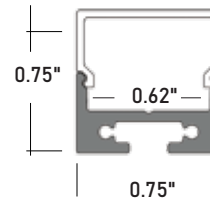

ALP-80 **SURFACE / SUSPENDED**
LENGTHS 49.25" , 98.5"
LENS Frosted
FINISH Anodized Aluminum

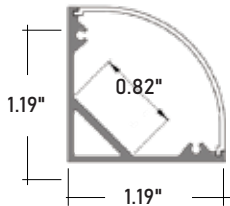

ALP-100C **SURFACE / CORNER**
LENGTHS 49.25" and 98.5"
LENS Frosted
FINISH Anodized Aluminum

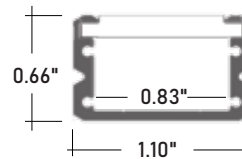

ALP-90 **SURFACE MOUNT**
LENGTHS 48" and 96"
LENS Frosted
FINISH Anodized Aluminum

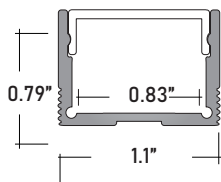

ALP-130 **SURFACE / SUSPENDED**
LENGTHS 49.25" and 98.5"
LENS Frosted
FINISH Anodized Aluminum

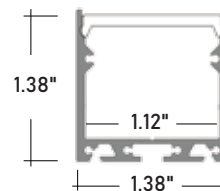

ALP-140 **SURFACE / SUSPENDED**
LENGTHS 49.25" and 98.5"
LENS Frosted
FINISH Anodized Aluminum

LSPW58X-RGB 5.8W Outdoor Color-Changing LED Strip

COMPATIBLE TOUCH SERIES CONTROLLERS

RGB-CT330

**RECEIVING CONTROLLER
INPUT
MAX OUTPUT CURRENT
MAX OUTPUT POWER
WORKING TEMP
WEIGHT (gross)**

12V - 24V DC
3A X 3CH
108W(12V), 216W (24V)
-30°C ~ 55°C
135g

RECEIVER

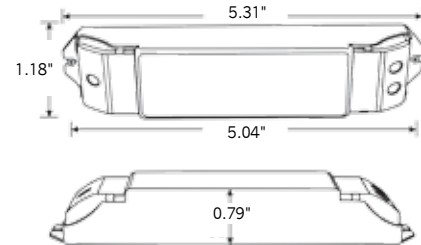

**HANDHELD REMOTE
INPUT VOLTAGE
WORKING FREQUENCY
REMOTE DISTANCE
WORKING TEMP
WEIGHT (gross)**

3V (CR2032 battery)
433.92MHz
90ft.
-30°C ~ 55°C
42g

HANDHELD REMOTE

REMOTE CRADLE

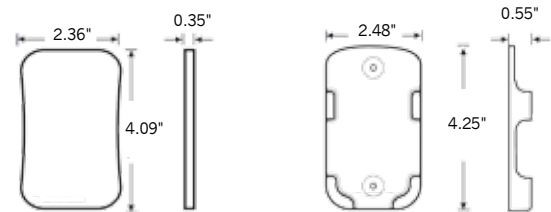

RGB-CT400

**RECEIVING CONTROLLER
INPUT
MAX OUTPUT CURRENT
MAX OUTPUT POWER
CONTROL BUTTON
WORKING TEMP
WEIGHT (gross)**

12V - 24V DC
5A X 3CH, 15A Max
180W(12V), 360W (24V)
8 touch button
-30°C ~ 55°C
180g

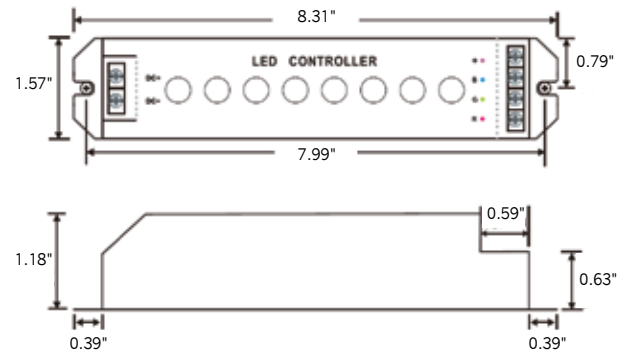

**RGB-CT400RX
(SOLD SEPARATELY)**

**HANDHELD REMOTE
INPUT VOLTAGE
WORKING CURRENT
WORKING FREQUENCY
REMOTE DISTANCE
CHANGE MODE
WEIGHT (gross)**

5V DC (Built-in Lithium battery)
< 30mA
2.4GHz
90ft.
32 modes
200g

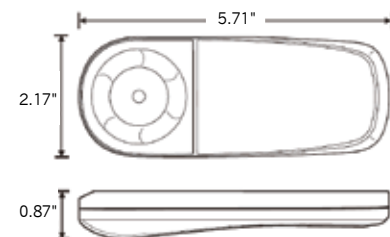

HANDHELD REMOTE

LSPW58X-RGB 5.8W Outdoor Color-Changing LED Strip

COMPATIBLE WALL CONTROLLERS

RGB-CT600	INPUT VOLTAGE	5V DC, 1A
	OUTPUT SIGNAL	RF 2.4GHz + DMX512
	CONTROL	4 ZONES
	WORKING TEMP	-30°C ~ 55°C
	WEIGHT (gross)	370g

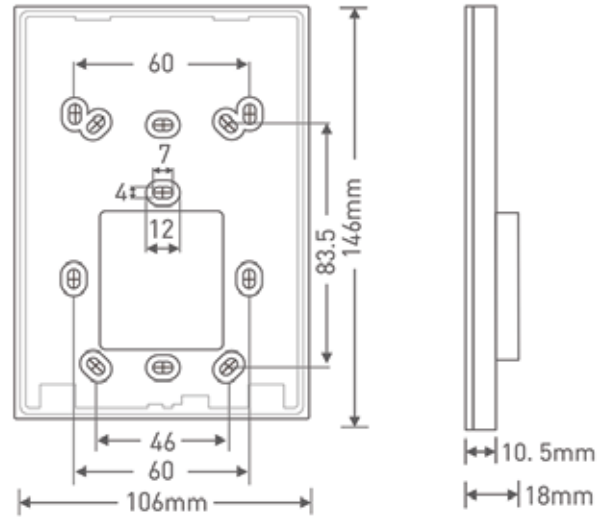

RGB-SDE3	INPUT POWER	6V DC 0.6A
	OUTPUT SIGNAL	DMX512 (x2)
	PROGRAMMABILITY	PC, MAC, Tablet, Smartphone
	AVAILABLE COLORS	Black / White
	CONNECTIONS	USB, Ethernet, RS232, Clock, 8dry contact ports, 5V output relay
MEMORY	microSD card	
WORKING TEMP	-10°C ~ 45°C	
MOUNTING	Single or double gang wall socket	
WEIGHT (gross)	247g	

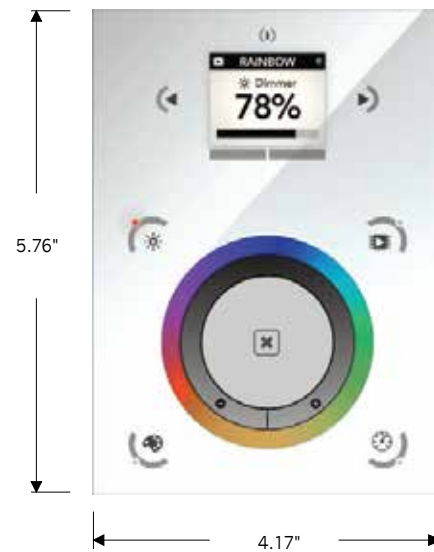

LSPW58X-RGB 5.8W Outdoor Color-Changing LED Strip

COMPATIBLE DMX RECEIVERS

RGB-DMX4C

INPUT 12V - 24V DC
OUTPUT CURRENT 8A X 4CH
OUTPUT POWER 240W(12V), 720W (24V)
OUTPUT CHANNELS 3 or 4 selectable

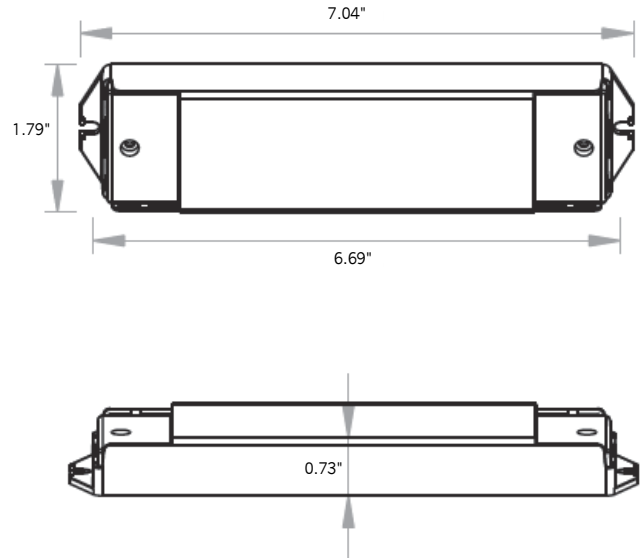

RGB-DMX5C-XLR

INPUT 12V-24V-36V DC
OUTPUT CURRENT 8A X 5CH

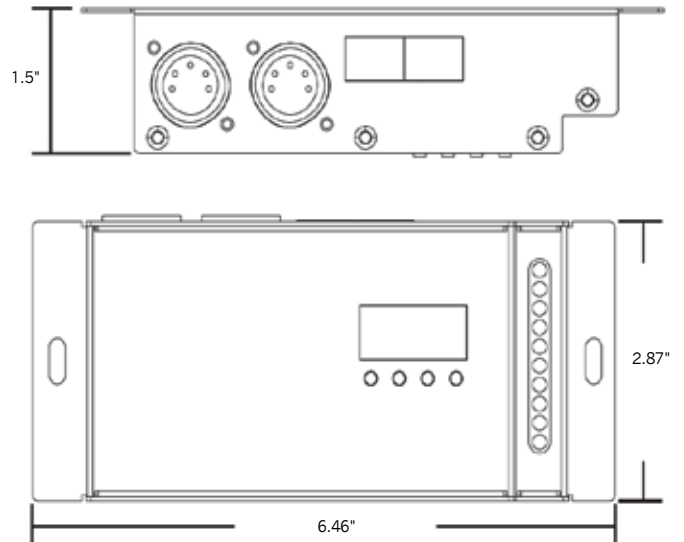

LSPW58X-RGB 5.8W Outdoor Color-Changing LED Strip

COMPATIBLE NON-DIMMING TRANSFORMERS

PSHW SERIES 24V	PSHW-10W-24V	PSHW-20W-24V	PSHW-35W-24V	PSHW-60W-24V	PSHW-100W-24V	PSHW-150W-24V	PSHW-200W-24V	PSHW-300W-24V
	YES	YES	YES	YES	NO	NO	NO	NO
	2.55" X 1.37" X .90"	4.64" X 1.38" X 1.2"	5.83" X 1.57" X 1.18"	6.38" X 1.65" X 1.18"	7.44" X 2.4" X 1.45"	8.75" X 2.68" X 1.53"	9.62" X 2.68" X 1.53"	9.92" X 3.55" X 1.75"

