

LSMW40HF

4.0W Outdoor Flexible LED Strip

JOB NAME: _____
LOCATION: _____
QUOTE/REF#: _____

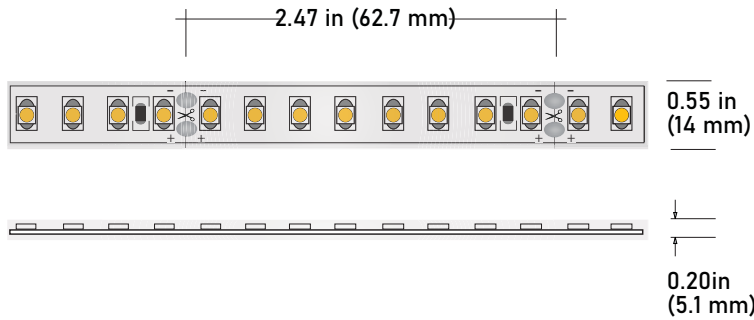

LSMW40HF is an outdoor, wet-rated and dimmable flexible LED strip capable of delivering 440 lumens of light output per ft. Rated to last 50,000 hours making it an excellent replacement for traditional halogen lighting. Its low profile design makes it suitable for use in cove lighting, under cabinets, displays, showcases and architectural and aesthetic projects.

SPECIFICATIONS

INPUT VOLTAGE	24V DC
POWER CONSUMPTION	4.0W per foot
LUMEN OUTPUT	440 Lumens per foot
NO. OF LEDs	40 LEDs per foot
BEAM ANGLE	120°
CRI	95+
DIMMING	MLV, ELV, 0-10 and TRIAC
MAXIMUM RUN LENGTH	16 Feet
FIELD CUTTABLE	Every 2.47"
IP RATING	IP65 wet location (outdoor)
LUMEN MAINTENANCE	50,000 hrs.
OPERATING TEMPERATURE	-40°F(-40°C)~+140°F(+60°C)
BINNING	1.5 Step Macadam Elipse
CERTIFICATIONS	UL listed, TITLE 24 JA8
DIMENSIONS	0.55" x 0.20 (width x height)

FEATURES

- 4.0W per Foot
- 440 Lumens per foot
- 95+ CRI
- California TITLE 24 JA8 compliant
- 110 lumens per watt
- Suitable for accent or ambient lighting
- Multiple CCT options available
- Superior COLOR RENDERING INDEX (CRI)
- UL Listed
- Dimmable with CORE Lighting dimmable drivers
- Approved for closet / storage space installation per NEC 410.16(A)(3) and 410.16(C)(5)

	COLOR TEMP	CRI	LUMEN/FT
	2700K	94	400
	3000K	94	400
	3500K	94	400
	4000K	94	440
	5000K	95	440
	6000K	97	440



LSMW40HF

4.0W Outdoor Flexible LED Strip

STANDARD ORDERING CODE

Model	Color Temp	Length	Voltage	Profile
LSMW40HF	27K 2700K	16 16.4 Ft.	24 24 Volts	² See p3 for options
	30K 3000K	25 25 Ft.		
	35K 3500K	32 32 Ft.		
	40K 4000K	¹ XX per Ft.		
	50K 5000K			
	60K 6000K			

NOTE:

- 1** = Custom length per Ft.
24V strip cuttable every 2.47"
- 2** = Custom color finishes require powder coating. Allow 7 days lead time.

COMPATIBLE ALUMINUM PROFILES

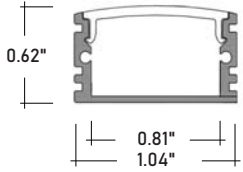

ALU-DS100 SURFACE MOUNT
LENGTHS 39³/₈" 78
LENS Clear and Frosted
FINISH Anodized Aluminum

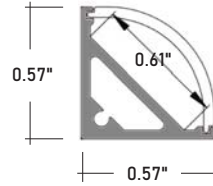

ALP-50C SURFACE / CORNER
LENGTHS 49.25" , 98.5"
LENS Frosted
FINISH Anodized Aluminum

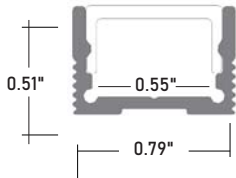

ALP-70 SURFACE MOUNT
LENGTHS 49.25" , 98.5"
LENS Frosted
FINISH Anodized Aluminum

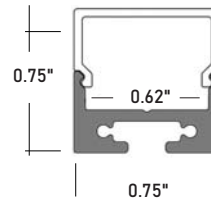

ALP-80 SURFACE / SUSPENDED
LENGTHS 49.25" , 98.5"
LENS Frosted
FINISH Anodized Aluminum

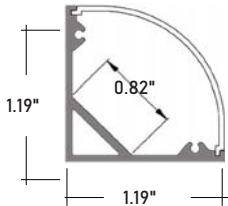

ALP-100C SURFACE / CORNER
LENGTHS 49.25" and 98.5"
LENS Frosted
FINISH Anodized Aluminum

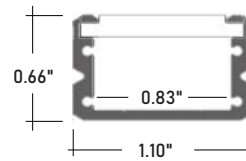

ALP-90 SURFACE MOUNT
LENGTHS 48" and 96"
LENS Frosted
FINISH Anodized Aluminum

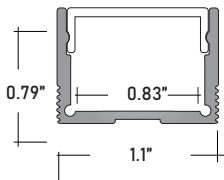

ALP-130 SURFACE / SUSPENDED
LENGTHS 49.25" and 98.5"
LENS Frosted
FINISH Anodized Aluminum

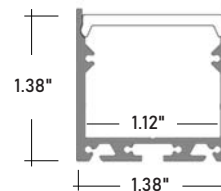

ALP-140 SURFACE / SUSPENDED
LENGTHS 49.25" and 98.5"
LENS Frosted
FINISH Anodized Aluminum

COMPATIBLE TRANSFORMERS

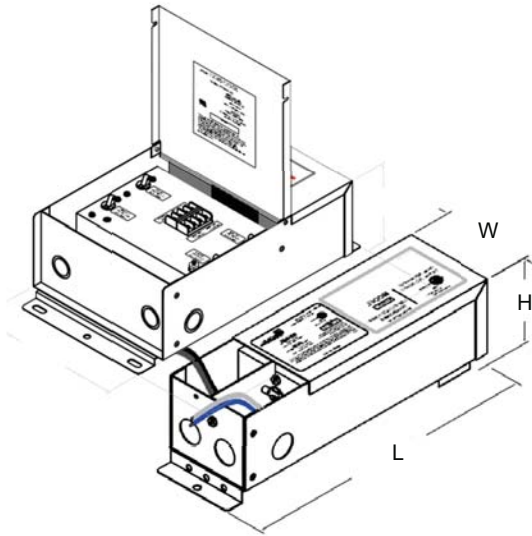

PSDH SERIES | HIGH PERFORMANCE MAGNETIC LOW VOLTAGE (MLV)

PSDH-48W-24V	CLASS 2	11.25"x 3.37"x 3.25"
PSDH-96W-24V	CLASS 2	11.25"x 3.37"x 3.25"
PSDH-288W-24V	CLASS 2	14.25"x 8.43"x 4.43"



PSDE SERIES | 0-10V DIMMING W/ JUNCTION BOX

PSDE-100W-24V-010-JB	CLASS 2	12.32" x 1.77" x 1.67"
-----------------------------	---------	------------------------



COMPATIBLE TRANSFORMERS

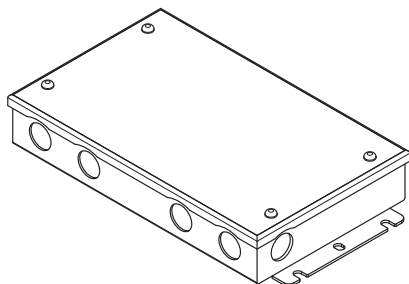

PSDL SERIES | TRIAC DIMMABLE

PSDL-30W-24V	CLASS 2	6.5"x 3.63"x 1.03"
PSDL-60W-24V	CLASS 2	7.4"x 3.63"x 1.03"
PSDL-96W-24V	CLASS 2	8.67"x 3.67"x 1.62"
PSDL-150W-24V		8.67"x 3.67"x 1.62"
PSDL-192W-24V	CLASS 2	10.25"x 4.06"x 1.82"
PSDL-200W-24V		10.25"x 4.06"x 1.82"
PSDL-288W-24V	CLASS 2	10.25"x 4.06"x 1.82"
PSDL-300W-24V		10.25"x 4.06"x 1.82"

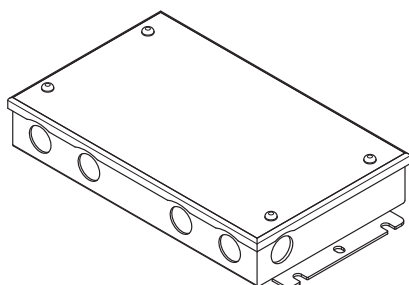

PSHK SERIES | NON-DIMMING W/ JUNCTION BOX

PSHK-30W-24V-UNV	CLASS 2	6.5" X 3.6" X 1.02"
PSHK-60W-24V-UNV	CLASS 2	7.4" X 3.62" X 1.02"
PSHK-96W-24V-UNV	CLASS 2	8.66" X 3.66" X 1.61"
PSHK-150W-24V-UNV		10.24" X 4.06" X 1.81"
PSHK-200W-24V-UNV		10.24" X 4.06" X 1.81"
PSHK-300W-24V-UNV		10.94" X 4.25" X 1.81"

LSMW40HF

4.0W Outdoor Flexible LED Strip

COMPATIBLE TRANSFORMERS

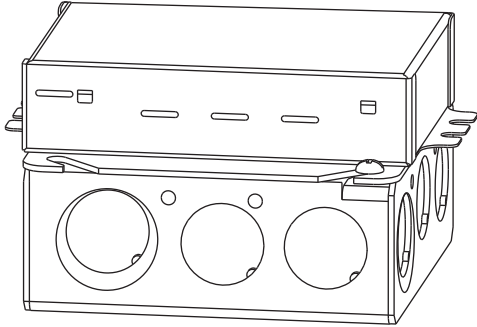

LUTRON 1% | 2 OR 3-WIRE DIMMING

LTEA4U1UKL-CV240	CLASS 2	4.0" x 1.5" x 4.0"
L3DA4U1UKL-CV240	CLASS 2	4.0" x 1.5" x 4.0"

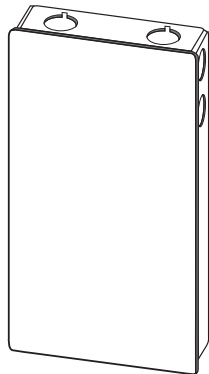

LUTRON 1%

PSDE-96W-24V-ECO	CLASS 2	10.5" x 3.0" x 2.0"
-------------------------	---------	---------------------