

LSMW35WD

3.6W Outdoor Auto Warm-Dim LED Strip

JOB NAME: _____
LOCATION: _____
QUOTE/REF#: _____

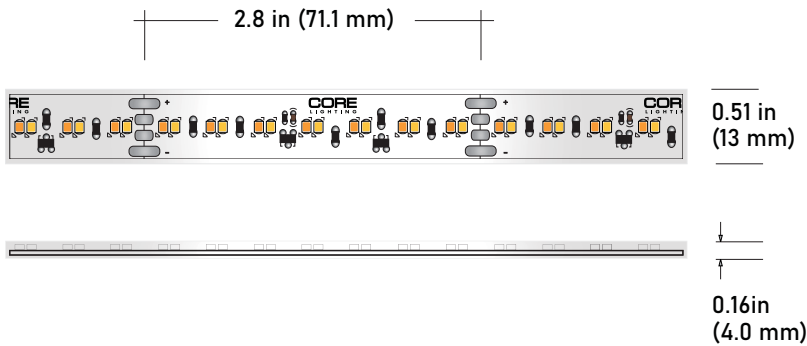

SPECIFICATIONS

INPUT VOLTAGE	24V DC
POWER CONSUMPTION	3.6W per foot
LUMEN OUTPUT	348 Lumens per foot (30K)
NO. OF LEDs	64 LEDs per foot
BEAM ANGLE	120°
CRI	90+
DIMMING	CL dimmers & PSDL Series
MAXIMUM RUN LENGTH	16.Feet
FIELD CUTTABLE	Every 2.8 in
IP RATING	IP65 wet location (outdoor)
LUMEN MAINTENANCE	50,000 hrs.
OPERATING TEMPERATURE	-40°F(-40°C)~+140°F(+60°C)
BINNING	1.5 Step Macadam Elipse
CERTIFICATIONS	UL listed, TITLE 24 JA8
DIMENSIONS	0.51" x 0.16 (width x height)

3.6W
PER FT.

348
LUMENS

95+
CRI

OUTDOOR

FIELD CUTTABLE

50,000 HOURS

DIMMABLE

UL
LISTED

WARRANTY
5 YEAR
WARRANTY

RoHS
COMPLIANT

LSMW35WD auto warm-dim outdoor LED strip with smart chip technology - using a standard wall box dimmer, this LED light source automatically shifts color temperature from 3000K down to 1800K as it is being dimmed down like traditional incandescent lighting. LSMW-35WD provides warm-dim technology at a fraction of the price without the need for any special control system. Its technologically advanced circuit puts the LSMW35WD at the forefront of lighting innovations geared towards functionality and energy efficiency.

FEATURES

- 3.6W per Foot
- 348 Lumens (30K)
- Auto warm-dim technology
- Field cuttable
- NO SPECIAL CONTROLLERS REQUIRED
- Architectural grade LED lighting
- Ideal for commercial and residential applications
- Works with CL dimmers and PSDL Series drivers
- Approved for closet / storage space installation per NEC 410.16(A)(3) and 410.16(C)(5)

NOTE: 2-WIRE DIMMING

	COLOR TEMP	CRI	LUMEN/FT
	1800K	90	315
	2700K	90	348
	3000K	90	348

LSMW35WD

3.6W Outdoor Auto Warm-Dim LED Strip

STANDARD ORDERING CODE

Model	Color Temp	Length	Voltage	Profile
LSMW35WD	18K/27K 1800K/2700K	16 16.4 Ft.	24 24 Volts	² See p3 for options
	18K/30K 1800K/3000K	¹ XX per Ft.		

NOTE:

- 1** = Custom length per Ft. cuttable every 2.8"
- 2** = Custom color finishes require powder coating. Allow 7 days lead time.

LSMW35WD

3.6W Outdoor Auto Warm-Dim LED Strip

COMPATIBLE ALUMINUM PROFILES

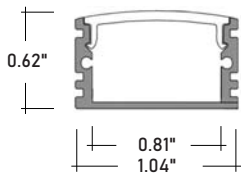

ALU-DS100 **SURFACE MOUNT**
LENGTHS 39 3/8" 78 7/8" 96"
LENS Clear and Frosted
FINISH Anodized Aluminum

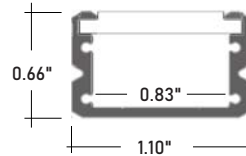

ALP-90 **SURFACE MOUNT**
LENGTHS 48" and 96"
LENS Frosted
FINISH Anodized Aluminum

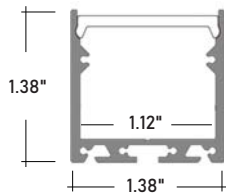

ALP-140 **SURFACE / SUSPENSION**
LENGTHS 49.25" , 98.5"
LENS Frosted
FINISH Anodized Aluminum

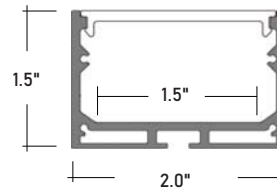

ALP-160 **SURFACE / SUSPENSION**
LENGTHS 49.25" , 98.5"
LENS Frosted
FINISH Anodized Aluminum

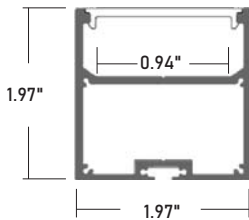

ALP-200 **SURFACE / SUSPENSION**
LENGTHS 49.25" , 98.5"
LENS Frosted
FINISH Anodized Aluminum

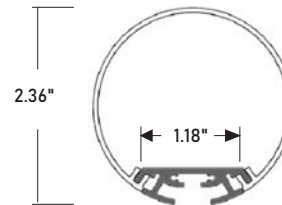

ALP-245 **SUSPENSION**
LENGTHS 49.25" , 98.5"
LENS Frosted
FINISH Anodized Aluminum

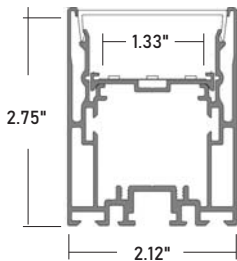

ALP-230N **SURFACE / SUSPENSION**
LENGTHS 49.25" , 98.5"
LENS Frosted
FINISH Anodized Aluminum

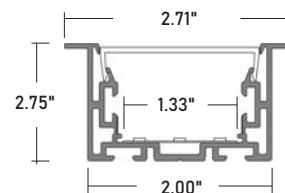

ALP-230RN **RECESSED**
LENGTHS 49.25" , 98.5"
LENS Frosted
FINISH Anodized Aluminum

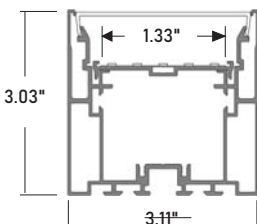

ALP-310N **SURFACE / SUSPENSION**
LENGTHS 49.25" , 98.5"
LENS Frosted
FINISH Anodized Aluminum

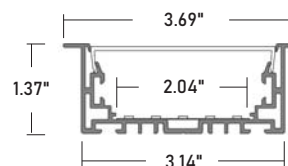

ALP-330RN **RECESSED**
LENGTHS 49.25" , 98.5"
LENS Frosted
FINISH Anodized Aluminum

LSMW35WD

3.6W Outdoor Auto Warm-Dim LED Strip

COMPATIBLE TRANSFORMERS

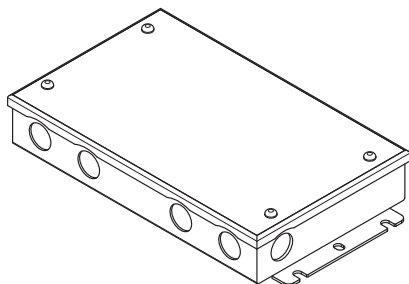

PSDL SERIES | TRIAC DIMMABLE

PSDL-30W-24V	CLASS 2	6.5" x 3.63" x 1.03"
PSDL-60W-24V	CLASS 2	7.4" x 3.63" x 1.03"
PSDL-96W-24V	CLASS 2	8.67" x 3.67" x 1.62"
PSDL-150W-24V	CLASS 2	8.67" x 3.67" x 1.62"
PSDL-192W-24V	CLASS 2	10.25" x 4.06" x 1.82"
PSDL-200W-24V	CLASS 2	10.25" x 4.06" x 1.82"
PSDL-288W-24V	CLASS 2	10.25" x 4.06" x 1.82"
PSDL-300W-24V	CLASS 2	10.25" x 4.06" x 1.82"

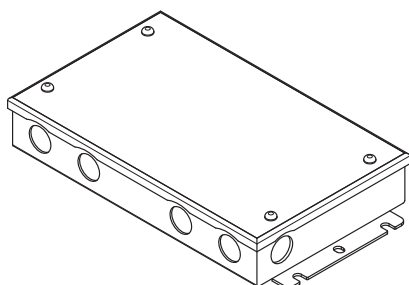

PSVT SERIES | 0-10V DIMMING WITH JUNCTION BOX

PSVT-60W-24V-UNV-010	CLASS 2	7.4" x 3.72" x 1.57"
PSVT-96W-24V-UNV-010	CLASS 2	8.66" x 3.72" x 1.57"
PSVT-200W-24V-UNV-010	CLASS 2	10.24" x 4.13" x 1.77"
PSVT-288W-24V-UNV-010	CLASS 2	11.85" x 4.25" x 1.81"
PSVT-300W-24V-UNV-010	CLASS 2	10.94" x 4.33" x 1.77"

LSMW35WD

3.6W Outdoor Auto Warm-Dim LED Strip

COMPATIBLE TRANSFORMERS

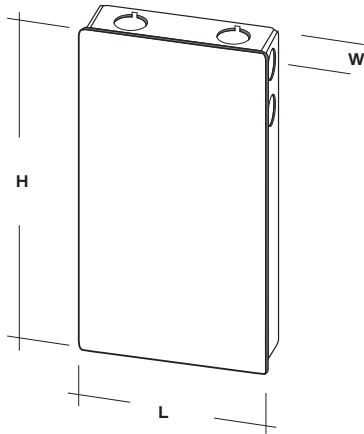

LUTRON 1%

PSDE-96W-24V-ECO

CLASS 2

10.5" x 3.0" x 2.0"