

LSMW15

1.5W Outdoor Flexible LED Strip

JOB NAME: _____
LOCATION: _____
QUOTE/REF#: _____

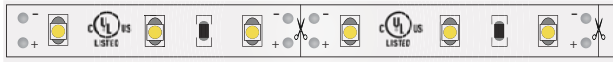
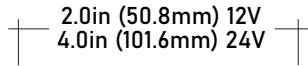

0.40 in
(10mm)



0.20 in
(5.1mm)









LSMW15 is an outdoor flexible LED strip that delivers 120 lumens at 1.5 Watts per ft. This LED strip is rated to last 50,000 hours making it an excellent replacement for halogen lighting. This product is suitable for use in most residential and commercial applications, it is easy to install. Offered in different CCT options with superior CRI.

SPECIFICATIONS

INPUT VOLTAGE	12V and 24V DC
POWER CONSUMPTION	1.5W per foot
LUMEN OUTPUT	120 Lumens per foot
NO. OF LEDs	18 LEDs per foot
BEAM ANGLE	120°
CRI	95+
DIMMING	MLV, ELV, 0-10 and TRIAC
MAXIMUM RUN LENGTH	16.4 Feet (12V strip) 24 Feet (24V strip)
FIELD CUTTABLE	Every 2 in (12V) Every 4 in (24V)
IP RATING	IP65 wet location (outdoor)
LUMEN MAINTENANCE	50,000 hrs.
OPERATING TEMPERATURE	-40°F(-40°C)~+140°F(+60°C)
BINNING	1.5 Step Macadam Elipse
CERTIFICATIONS	UL listed, TITLE 24 JA8
DIMENSIONS	0.47" x 0.20 (width x height)

FEATURES

- 1.5W / Ft.
- 95+ CRI
- California TITLE 24 JA8 compliant
- Field cuttable
- Suitable for accent or ambient lighting
- Multiple CCT options available
- Available in 12V and 24V
- UL Listed
- Dimmable with CORE Lighting dimmable drivers
- Approved for closet / storage space installation per NEC 410.16(A)(3) and 410.16(C)(5)

	COLOR TEMP	CRI	LUMEN/FT
	2200K	94	102
	2500K	95	112
	2700K	98	115
	3000K	98	120
	3500K	97	121
	4000K	96	124
	5000K	95	126
	6000K	95	128



STANDARD ORDERING CODE

Model	Color Temp	Length	Voltage	Profile
LSMW15	22K 2200K	16 16.4 Ft.	12 12 Volts	² See p3 for options
	24K 2400K	32 32 Ft.	24 24 Volts	
	27K 2700K	¹ XX per Ft.		
	30K 3000K			
	35K 3500K			
	40K 4000K			
	50K 5000K			
	60K 6000K			
	RD Red			
	BL Blue			
	GR Green			
	PK Pink			
	PR Purple			
AM Amber				
OR Orange				

NOTE:

- 1** = Custom length per Ft.
12V strip cuttable every 2"
24V strip cuttable every 4"
- 2** = Custom color finishes require powder coating. Allow 7 days lead time.

LSMW15

1.5W Outdoor Flexible LED Strip

COMPATIBLE ALUMINUM PROFILES

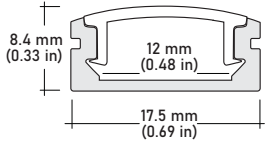

ALU-SF Surface
LENGTHS 39^{3/8}" | 78^{7/8}" | 98"
LENS Clear, Frosted
FINISH Silver | Black

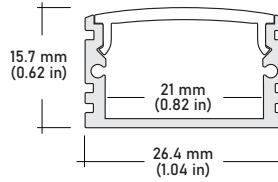

ALU-DS100 Surface Wide
LENGTHS 39^{3/8}" | 78^{7/8}" | 96"
LENS Clear, Frosted
FINISH Silver

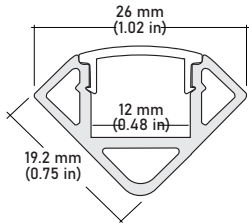

ALU-CN Surface, Corner
LENGTHS 39^{3/8}" | 78^{7/8}" | 96"
LENS Clear, Frosted
FINISH Silver | Black

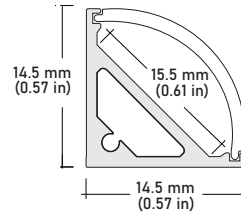

ALP-50C Surface, Corner
LENGTHS 49.25" | 98.5"
LENS Frosted
FINISH White | Black | Silver

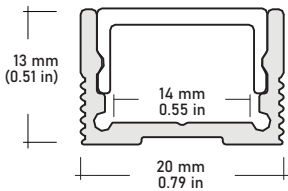

ALP-70 Surface
LENGTHS 49.25" | 98.5"
LENS Frosted
FINISH White | Black | Silver

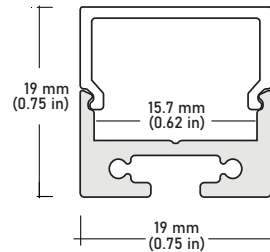

ALP-80 Surface, Suspended
LENGTHS 49.25" | 98.5"
LENS Frosted
FINISH Silver

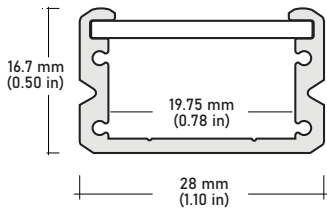

ALP-90 Surface
LENGTHS 48" | 96"
LENS Frosted
FINISH Silver

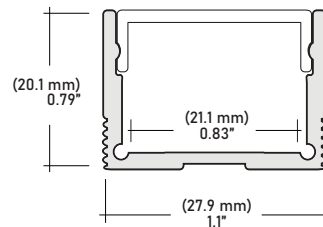

ALP-130 Surface, Suspended
LENGTHS 49.25" | 98.5"
LENS Frosted
FINISH Silver

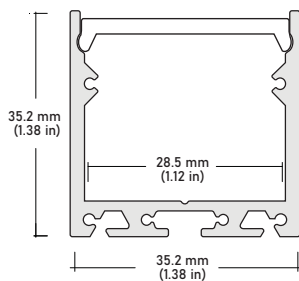

ALP-140 Surface, Suspended
LENGTHS 49.25" | 98.5"
LENS Frosted
FINISH Silver

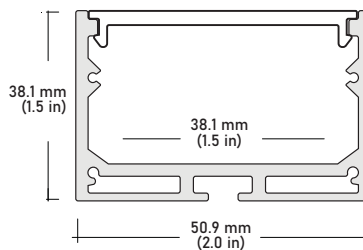

ALP-160 Surface, Suspended
LENGTHS 48" | 98"
LENS Frosted
FINISH Silver

LSMW15

1.5W Outdoor Flexible LED Strip

COMPATIBLE TRANSFORMERS

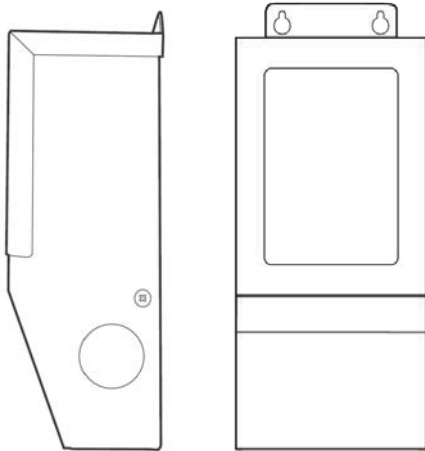

PSDM 24V SERIES | DIMMABLE MAGNETIC LOW VOLTAGE (MLV)

PSDM-20W-12V	CLASS 2	5.6" x 2" x 2.14"
PSDM-40W-12V	CLASS 2	5.6" x 2" x 2.14"
PSDM-60W-12V	CLASS 2	6.5" x 2.3" x 2.5"
PSDM-100W-12V	CLASS 2	9.8" x 3" x 3"
PSDM-150W-12V		9.8" x 3" x 3"
PSDM-180W-12V		9.8" x 3" x 3"
PSDM-200W-12V		9.8" x 3" x 3"
PSDM-300W-12V		9.8" x 4.2" x 3.5"
PSDM-300W-12V		7.0" x 7.0" x 3.2"

PSDM-20W-24V	CLASS 2	5.6" x 2" x 2.14"
PSDM-40W-24V	CLASS 2	5.6" x 2" x 2.14"
PSDM-60W-24V	CLASS 2	6.5" x 2.3" x 2.5"
PSDM-100W-24V	CLASS 2	6.5" x 2.3" x 2.5"
PSDM-150W-24V		9.8" x 3" x 3"
PSDM-192W-24V	CLASS 2	7.0" x 7.0" x 3.2"
PSDM-200W-24V		9.8" x 3" x 3"
PSDM-288W-24V	CLASS 2	9.8" x 4.2" x 3.5"
PSDM-300W-24V		7.0" x 7.0" x 3.2"

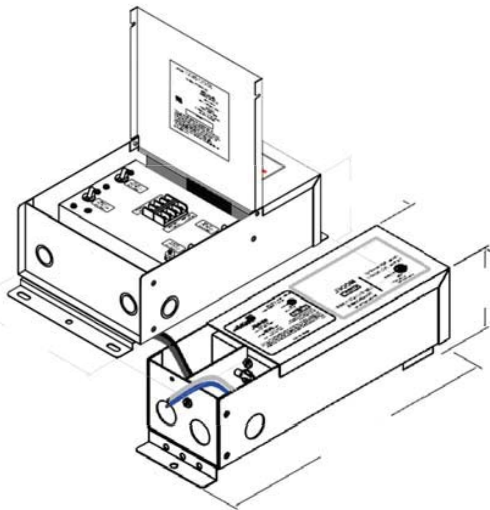

PSDH SERIES | HIGH PERFORMANCE MAGNETIC LOW VOLTAGE (MLV)

PSDH-48W-24V	CLASS 2	11.25" x 3.37" x 3.25"
PSDH-96W-24V	CLASS 2	11.25" x 3.37" x 3.25"
PSDH-288W-24V	CLASS 2	14.25" x 8.43" x 4.43"

LSMW15

1.5W Outdoor Flexible LED Strip

COMPATIBLE TRANSFORMERS

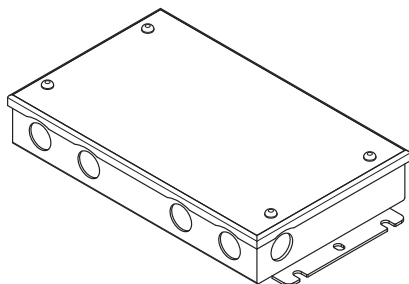

PSDL SERIES | TRIAC DIMMABLE

PSDL-30W-12V	CLASS 2	6.5"x 3.63"x 1.03"
PSDL-60W-12V	CLASS 2	7.4"x 3.63"x 1.03"
PSDL-100W-12V	CLASS 2	8.67"x 3.67"x 1.62"
PSDL-120W-12V		8.67"x 3.67"x 1.62"
PSDL-150W-12V		10.25"x 4.06"x 1.82"
PSDL-200W-12V		10.25"x 4.06"x 1.82"
PSDL-300W-12V		10.25"x 4.06"x 1.82"

PSDL-30W-24V	CLASS 2	6.5"x 3.63"x 1.03"
PSDL-60W-24V	CLASS 2	7.4"x 3.63"x 1.03"
PSDL-96W-24V	CLASS 2	8.67"x 3.67"x 1.62"
PSDL-150W-24V	CLASS 2	8.67"x 3.67"x 1.62"
PSDL-192W-24V	CLASS 2	10.25"x 4.06"x 1.82"
PSDL-200W-24V		10.25"x 4.06"x 1.82"
PSDL-288W-24V		10.25"x 4.06"x 1.82"
PSDL-300W-24V		10.25"x 4.06"x 1.82"

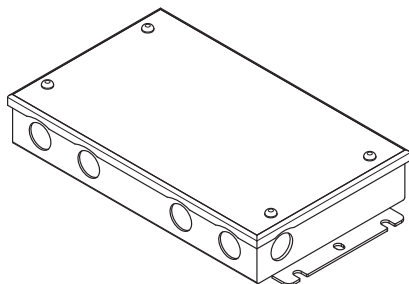

PSHK SERIES | NON-DIMMING W/ JUNCTION BOX

PSHK-30W-24V-UNV	CLASS 2	6.5" X 3.6" X 1.02"
PSHK-60W-24V-UNV	CLASS 2	7.4" X 3.62" X 1.02"
PSHK-96W-24V-UNV	CLASS 2	8.66" X 3.66" X 1.61"
PSHK-150W-24V-UNV		10.24" X 4.06" X 1.81"
PSHK-200W-24V-UNV		10.24" X 4.06" X 1.81"
PSHK-300W-24V-UNV		10.94" X 4.25" X 1.81"

LSMW15

1.5W Outdoor Flexible LED Strip

COMPATIBLE TRANSFORMERS



PSDE SERIES | 0-10V DIMMING W/ JUNCTION BOX

PSDE-100W-24V-010-JB CLASS 2 12.32" x 1.77" x 1.67"



LUTRON 1% | 2 OR 3-WIRE DIMMING

LTEA4U1UKL-CV240 CLASS 2 4.0" x 1.5" x 4.0"

L3DA4U1UKL-CV240 CLASS 2 4.0" x 1.5" x 4.0"

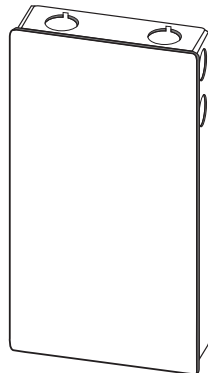
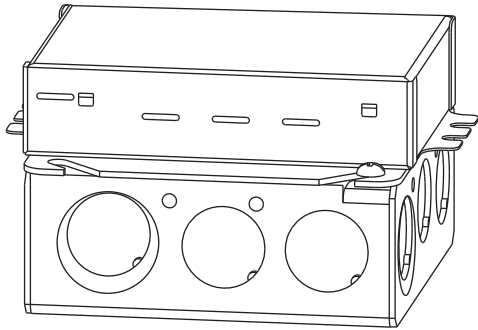

LUTRON 1%

PSDE-96W-24V-ECO CLASS 2 10.5" x 3.0" x 2.0"