

# LSM45

## 4.4W Indoor Flexible LED Strip

JOB NAME: \_\_\_\_\_  
LOCATION: \_\_\_\_\_  
QUOTE/REF#: \_\_\_\_\_

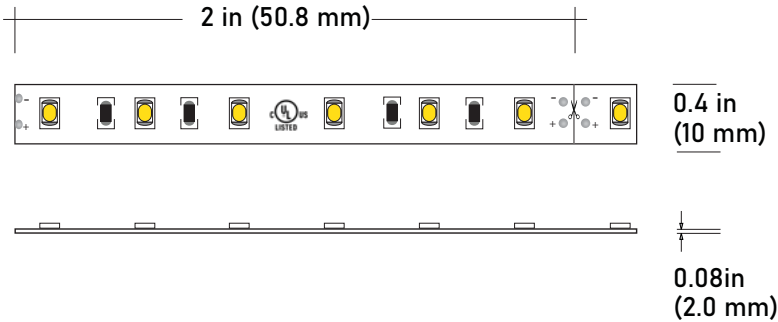

**LSM45** is a dimmable flexible LED strip capable of delivering 370 lumens of light output per Ft. Its high lumen output, excellent color rendering and color temperature options make it the perfect choice for almost any commercial or residential lighting application.

### SPECIFICATIONS

<b>INPUT VOLTAGE</b>	24V DC
<b>POWER CONSUMPTION</b>	4.4W per foot
<b>LUMEN OUTPUT</b>	370 Lumens per foot
<b>NO. OF LEDs</b>	36 LEDs per foot
<b>BEAM ANGLE</b>	120°
<b>CRI</b>	95+
<b>DIMMING</b>	MLV, ELV, 0-10 and TRIAC
<b>MAXIMUM RUN LENGTH</b>	30 Feet
<b>FIELD CUTTABLE</b>	Every 2 in (50.8MM)
<b>IP RATING</b>	IP45 dry location (indoor)
<b>LUMEN MAINTENANCE</b>	50,000 hrs.
<b>OPERATING TEMPERATURE</b>	-40°F(-40°C)~+140°F(+60°C)
<b>BINNING</b>	1.5 Step Macadam Elipse
<b>CERTIFICATIONS</b>	UL listed, TITLE 24 JA8
<b>DIMENSIONS</b>	0.4" x 0.08 (width x height)

### FEATURES

- 4.4W per Foot
- 370 Lumens
- 95+ CRI
- California TITLE 24 JA8 compliant
- Field cuttable
- Suitable for accent or ambient lighting
- Multiple CCT options available
- Superior COLOR RENDERING INDEX (CRI)
- Available in 24V
- UL Listed
- Dimmable with CORE Lighting dimmable drivers
- Approved for closet / storage space installation per NEC 410.16(A)(3) and 410.16(C)(5)



	COLOR TEMP	CRI	LUMEN/FT
	2500K	95	356
	2700K	95	356
	3000K	95	360
	3500K	95	368
	4000K	95	372
	5000K	95	376
	6000K	97	380

## STANDARD ORDERING CODE

Model	Color Temp	Length	Voltage	Profile
LSM-45	<b>25K</b> 2500K	<b>16</b> 16.4 Ft.	<b>24</b> 24 Volts	<sup>2</sup> See p3 for options
	<b>27K</b> 2700K	<b>100</b> 100 Ft.		
	<b>30K</b> 3000K	<b>1XX</b> per Ft.		
	<b>35K</b> 3500K			
	<b>40K</b> 4000K			
	<b>50K</b> 5000K			
	<b>60K</b> 6000K			

### NOTE:

- 1** = Custom length per Ft. cuttable every 2"
- 2** = Custom color finishes require powder coating. Allow 7 days lead time.

# LSM45

4.4W Indoor Flexible LED Strip

## COMPATIBLE ALUMINUM PROFILES

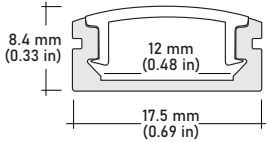

**ALU-SF** Surface  
**LENGTHS** 39<sup>3/8</sup>" | 78<sup>7/8</sup>" | 84" | 98"  
**LENS** Clear, Frosted  
**FINISH** Silver | Black

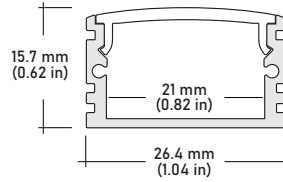

**ALU-DS100** Surface Wide  
**LENGTHS** 39<sup>3/8</sup>" | 78<sup>7/8</sup>" | 84"  
**LENS** Clear, Frosted  
**FINISH** Silver

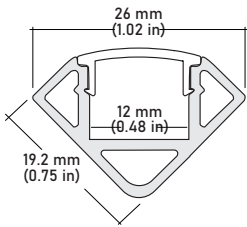

**ALU-CN** Surface, Corner  
**LENGTHS** 39<sup>3/8</sup>" | 78<sup>7/8</sup>" | 84" | 96"  
**LENS** Clear, Frosted  
**FINISH** Silver | Black

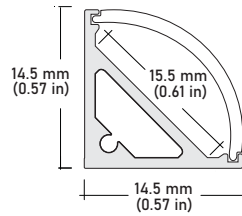

**ALP-50C** Surface, Corner  
**LENGTHS** 49.25" | 84" | 98.5"  
**LENS** Frosted  
**FINISH** White | Black | Silver

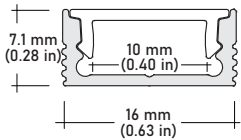

**ALP-20** Surface  
**LENGTHS** 49.25" | 84" | 98.5"  
**LENS** Frosted  
**FINISH** White | Black | Silver

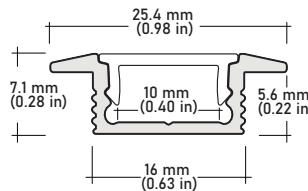

**ALP-20R** Recessed  
**LENGTHS** 49.25" | 98.5"  
**LENS** Frosted  
**FINISH** White | Black | Silver

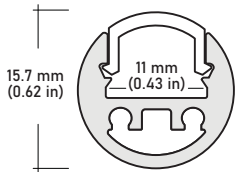

**ALP-35** Surface  
**LENGTHS** 48" | 96"  
**LENS** Frosted  
**FINISH** Silver

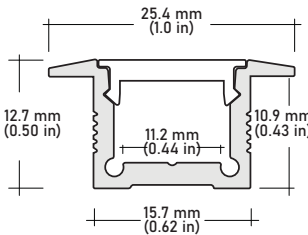

**ALP-60R** Recessed  
**LENGTHS** 49.25" | 84" | 98.5"  
**LENS** Frosted  
**FINISH** White | Black | Silver

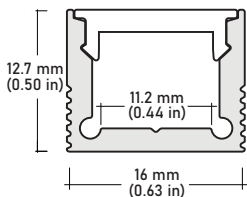

**ALP-60** Surface  
**LENGTHS** 49.25" | 84" | 98.5"  
**LENS** Frosted  
**FINISH** White | Black | Silver

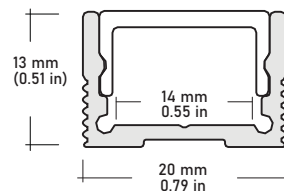

**ALP-70** Surface  
**LENGTHS** 49.25" | 84" | 98.5"  
**LENS** Frosted  
**FINISH** White | Black | Silver

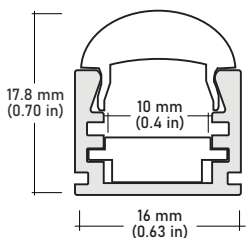

**ALP-65** Surface  
**LENGTHS** 49.25" | 84" | 98.5"  
**LENS** Frosted  
**FINISH** Silver  
**OPTICS** 10° | 30° | 60°

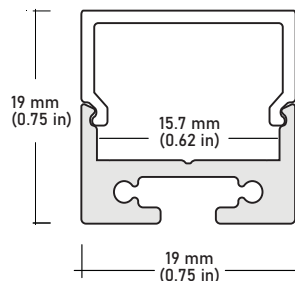

**ALP-80** Surface, Suspended  
**LENGTHS** 49.25" | 98.5"  
**LENS** Frosted  
**FINISH** Silver

## COMPATIBLE TRANSFORMERS

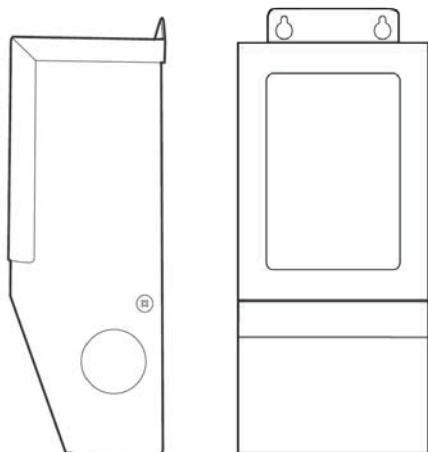

### PSDM 24V SERIES | DIMMABLE MAGNETIC LOW VOLTAGE (MLV)

<b>PSDM-20W-24V</b>	CLASS 2	5.6" x 2" x 2.14"
<b>PSDM-40W-24V</b>	CLASS 2	5.6" x 2" x 2.14"
<b>PSDM-60W-24V</b>	CLASS 2	6.5" x 2.3" x 2.5"
<b>PSDM-100W-24V</b>	CLASS 2	6.5" x 2.3" x 2.5"
<b>PSDM-150W-24V</b>		9.8" x 3" x 3"
<b>PSDM-192W-24V</b>	CLASS 2	7.0" x 7.0" x 3.2"
<b>PSDM-200W-24V</b>		9.8" x 3" x 3"
<b>PSDM-288W-24V</b>	CLASS 2	9.8" x 4.2" x 3.5"
<b>PSDM-300W-24V</b>		7.0" x 7.0" x 3.2"

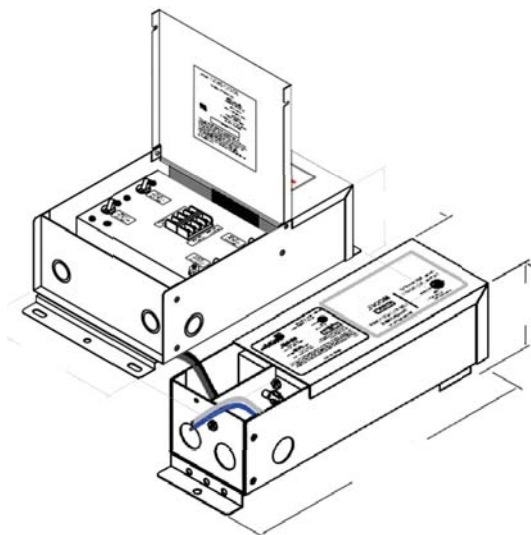

### PSDH SERIES | HIGH PERFORMANCE MAGNETIC LOW VOLTAGE (MLV)

<b>PSDH-48W-24V</b>	CLASS 2	11.25" x 3.37" x 3.25"
<b>PSDH-96W-24V</b>	CLASS 2	11.25" x 3.37" x 3.25"
<b>PSDH-288W-24V</b>	CLASS 2	14.25" x 8.43" x 4.43"

## COMPATIBLE TRANSFORMERS

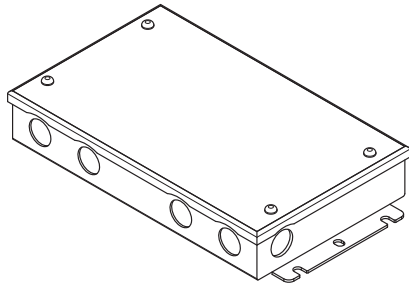

### PSDL SERIES | TRIAC DIMMABLE

<b>PSDL-30W-24V</b>	CLASS 2	6.5"x 3.63"x 1.03"
<b>PSDL-60W-24V</b>	CLASS 2	7.4"x 3.63"x 1.03"
<b>PSDL-96W-24V</b>	CLASS 2	8.67"x 3.67"x 1.62"
<b>PSDL-150W-24V</b>	CLASS 2	8.67"x 3.67"x 1.62"
<b>PSDL-192W-24V</b>	CLASS 2	10.25"x 4.06"x 1.82"
<b>PSDL-200W-24V</b>	CLASS 2	10.25"x 4.06"x 1.82"
<b>PSDL-288W-24V</b>	CLASS 2	10.25"x 4.06"x 1.82"
<b>PSDL-300W-24V</b>	CLASS 2	10.25"x 4.06"x 1.82"

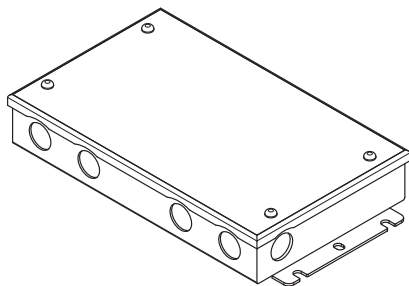

### PSHK SERIES | NON-DIMMING W/ JUNCTION BOX

<b>PSHK-30W-24V-UNV</b>	CLASS 2	6.5" X 3.6" X 1.02"
<b>PSHK-60W-24V-UNV</b>	CLASS 2	7.4" X 3.62" X 1.02"
<b>PSHK-96W-24V-UNV</b>	CLASS 2	8.66" X 3.66" X 1.61"
<b>PSHK-150W-24V-UNV</b>	CLASS 2	10.24" X 4.06" X 1.81"
<b>PSHK-200W-24V-UNV</b>	CLASS 2	10.24" X 4.06" X 1.81"
<b>PSHK-300W-24V-UNV</b>	CLASS 2	10.94" X 4.25" X 1.81"

## COMPATIBLE TRANSFORMERS



**PSDE SERIES** | 0-10V DIMMING W/ JUNCTION BOX

**PSDE-100W-24V-010-JB** CLASS 2 12.32" x 1.77" x 1.67"

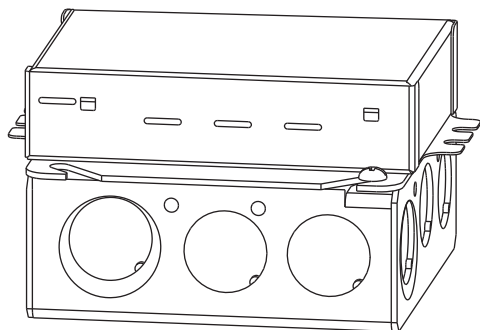

**LUTRON 1%** | 2 OR 3-WIRE DIMMING

**LTEA4U1UKL-CV240** CLASS 2 4.0" x 1.5" x 4.0"

**L3DA4U1UKL-CV240** CLASS 2 4.0" x 1.5" x 4.0"

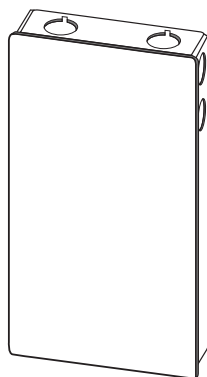

**LUTRON 1%**

**PSDE-96W-24V-ECO** CLASS 2 10.5" x 3.0" x 2.0"

## COMPATIBLE CONNECTORS



### HP PRO CONNECTORS | QUICK CONNECT SNAP-ON

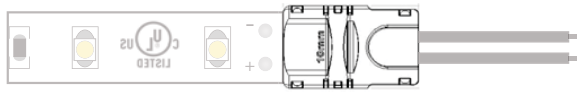

<b>LSA-HW8-HP</b>	8" CONNECTOR	0.95" x 0.57" x 0.30"
<b>LSA-HW24-HP</b>	24" CONNECTOR	0.95" x 0.57" x 0.30"
<b>LSA-HW60-HP</b>	60" CONNECTOR	0.95" x 0.57" x 0.30"
<b>LSA-HW120-HP</b>	120" CONNECTOR	0.95" x 0.57" x 0.30"



<b>LSA-EX3-HP</b>	3" LINK	0.95" x 0.57" x 0.30"
<b>LSA-EX8-HP</b>	8" LINK	0.95" x 0.57" x 0.30"
<b>LSA-EX24-HP</b>	24" LINK	0.95" x 0.57" x 0.30"

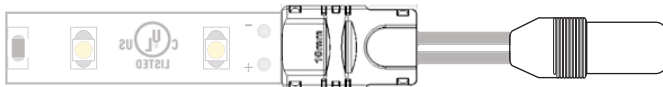

<b>LSA-DC24-HP</b>	24" DC CONNECTOR	0.95" x 0.57" x 0.30"
--------------------	------------------	-----------------------

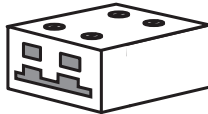

### LSA-TB | SOLDERLESS LED STRIP / WIRE BLOCK CONNECTOR

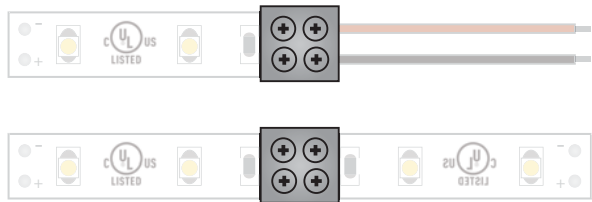

<b>LSA-TB-HWC</b>	6A HARDWIRE CONNECTOR	0.43" x 0.47" x 0.31"
<b>LSA-TB-MC</b>	STRIP TO STRIP COUPLING	0.43" x 0.47" x 0.31"
<b>LSA-TB-HWP-10A</b>	10A HARDWIRE CONNECTOR	0.55" x 0.55" x 0.35"