

LSM40HF

4.0W Indoor Flexible LED Strip

JOB NAME: _____
LOCATION: _____
QUOTE/REF#: _____

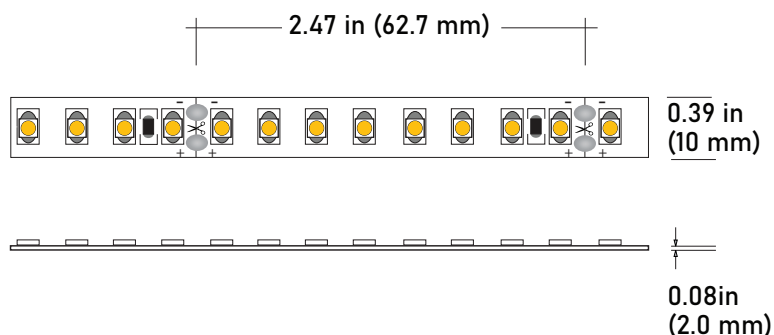

LSM40HF is an High-Flux indoor, dimmable flexible LED strip capable of delivering 110 Lumens per watt of light output per ft. Its high lumen output, excellent color rendering, and various color temperature options make it the perfect choice for almost any commercial or residential lighting application.

SPECIFICATIONS

INPUT VOLTAGE	24V DC
POWER CONSUMPTION	4W per Ft.
LUMEN OUTPUT	440 Lumens per Ft.
NO. OF LEDs	40 LEDs per Ft.
BEAM ANGLE	120°
CRI	90+
DIMMING	Standard CL dimmers
MAXIMUM RUN LENGTH	16 Ft.
FIELD CUTTABLE	Every 2.47 in (62.7MM)
IP RATING	IP45 dry location (indoor)
LUMEN MAINTENANCE	50,000 hrs.
OPERATING TEMPERATURE	-40°F(-40°C)~+140°F(+60°C)
BINNING	1.5 Step Macadam Elipse
CERTIFICATIONS	UL listed
DIMENSIONS	0.47" x 0.08 (width x height)

FEATURES

- 4.0W per Ft.
- 440 Lumens
- 90+ CRI
- California TITLE 24 JA8 compliant
- 110 Lumens per watt
- Ideal for accent and ambient lighting
- Multiple CCT options available
- UL Listed
- Dimmable with CORE dimmable drivers
- Approved for closet / storage space installation per NEC 410.16(A)(3) and 410.16(C)(5)

	COLOR TEMP	CRI	LUMEN/FT
	2400K	94	400
	2700K	94	400
	3000K	94	400
	3500K	94	440
	4000K	94	440
	5000K	95	440
	6000K	97	440



STANDARD ORDERING CODE

Model	Color Temp	Length	Voltage	Profile
LSM40HF	24K 2400K	16 16.4 Ft.	24 24 Volts	²See p3 for options
	27K 2700K	100 100 Ft.		
	30K 3000K	¹XX per Ft.		
	35K 3500K			
	40K 4000K			
	50K 5000K			
	60K 6000K			

NOTE:

- 1** = Custom length per Ft. cuttable every 2.47"
- 2** = Custom color finishes require powder coating. Allow 7 days lead time.

COMPATIBLE ALUMINUM PROFILES

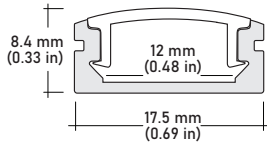

ALU-SF Surface
LENGTHS 39^{3/8"} | 78^{7/8"} | 84" | 98"
LENS Clear, Frosted
FINISH Silver | Black

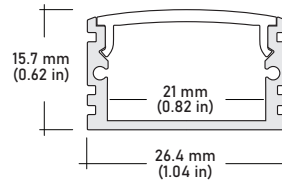

ALU-DS100 Surface Wide
LENGTHS 39^{3/8"} | 78^{7/8"} | 84"
LENS Clear, Frosted
FINISH Silver

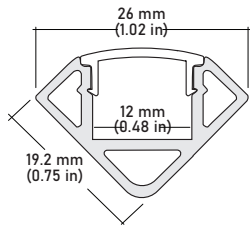

ALU-CN Surface, Corner
LENGTHS 39^{3/8"} | 78^{7/8"} | 84" | 96"
LENS Clear, Frosted
FINISH Silver | Black

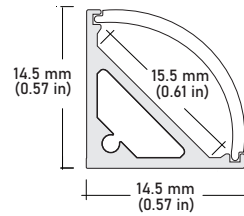

ALP-50C Surface, Corner
LENGTHS 49.25" | 84" | 98.5"
LENS Frosted
FINISH White | Black | Silver

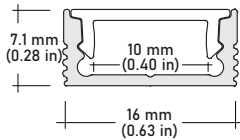

ALP-20 Surface
LENGTHS 49.25" | 84" | 98.5"
LENS Frosted
FINISH White | Black | Silver

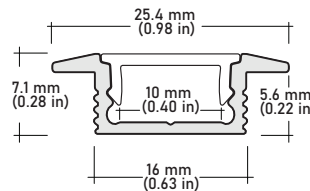

ALP-20R Recessed
LENGTHS 49.25" | 98.5"
LENS Frosted
FINISH White | Black | Silver

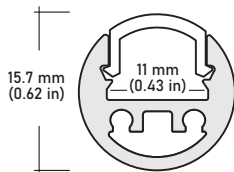

ALP-35 Surface
LENGTHS 48" | 96"
LENS Frosted
FINISH Silver

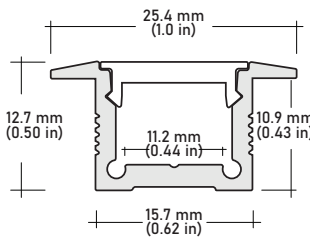

ALP-60R Recessed
LENGTHS 49.25" | 84" | 98.5"
LENS Frosted
FINISH White | Black | Silver

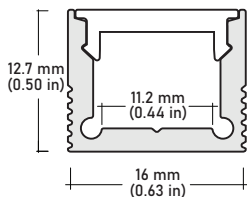

ALP-60 Surface
LENGTHS 49.25" | 84" | 98.5"
LENS Frosted
FINISH White | Black | Silver

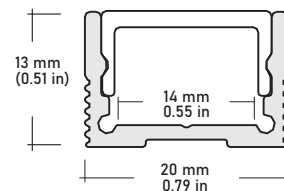

ALP-70 Surface
LENGTHS 49.25" | 84" | 98.5"
LENS Frosted
FINISH White | Black | Silver

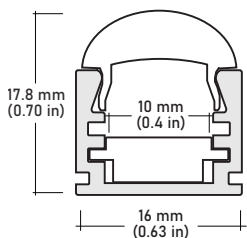

ALP-65 Surface
LENGTHS 49.25" | 84" | 98.5"
LENS Frosted
FINISH Silver
OPTICS 10° | 30° | 60°

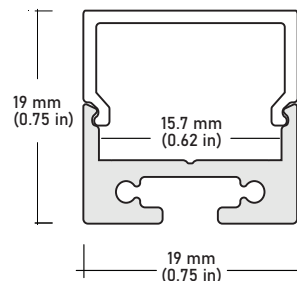

ALP-80 Surface, Suspended
LENGTHS 49.25" | 98.5"
LENS Frosted
FINISH Silver

COMPATIBLE TRANSFORMERS

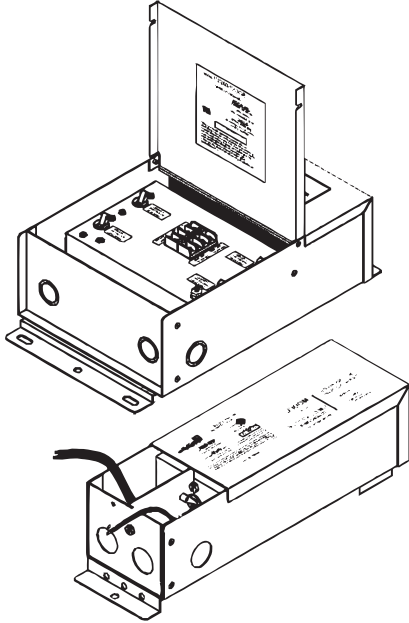

PSDH SERIES | HIGH PERFORMANCE MAGNETIC LOW VOLTAGE (MLV)

PSDH-48W-24V	CLASS 2	11.25"x 3.37"x 3.25"
PSDH-96W-24V	CLASS 2	11.25"x 3.37"x 3.25"
PSDH-288W-24V	CLASS 2	14.25"x 8.43"x 4.43"

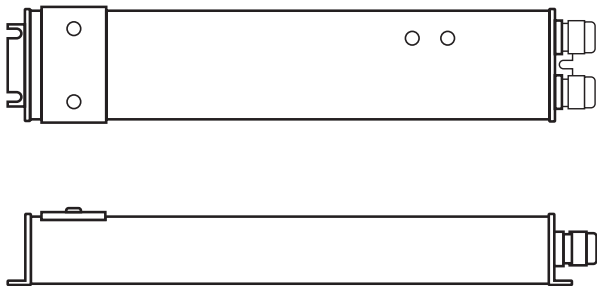

PSDE SERIES | 0-10V DIMMING W/ JUNCTION BOX

PSDE-100W-24V-010-JB	CLASS 2	12.32" x 1.77" x 1.67"
-----------------------------	---------	------------------------

COMPATIBLE TRANSFORMERS

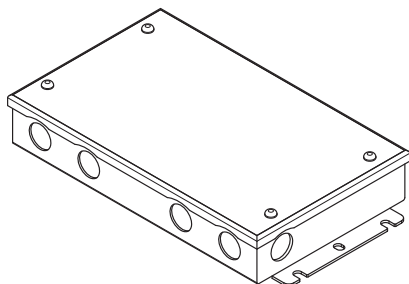

PSDL SERIES | TRIAC DIMMABLE

PSDL-30W-24V	CLASS 2	6.5"x 3.63"x 1.03"
PSDL-60W-24V	CLASS 2	7.4"x 3.63"x 1.03"
PSDL-96W-24V	CLASS 2	8.67"x 3.67"x 1.62"
PSDL-150W-24V		8.67"x 3.67"x 1.62"
PSDL-192W-24V	CLASS 2	10.25"x 4.06"x 1.82"
PSDL-200W-24V		10.25"x 4.06"x 1.82"
PSDL-288W-24V	CLASS 2	10.25"x 4.06"x 1.82"
PSDL-300W-24V		10.25"x 4.06"x 1.82"

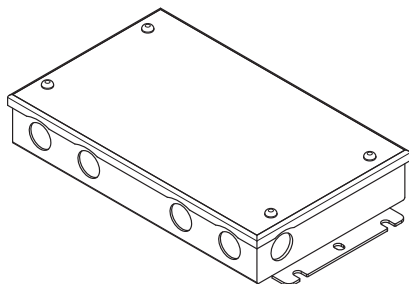

PSHK SERIES | NON-DIMMING W/ JUNCTION BOX

PSHK-30W-24V-UNV	CLASS 2	6.5" X 3.6" X 1.02"
PSHK-60W-24V-UNV	CLASS 2	7.4" X 3.62" X 1.02"
PSHK-96W-24V-UNV	CLASS 2	8.66" X 3.66" X 1.61"
PSHK-150W-24V-UNV		10.24" X 4.06" X 1.81"
PSHK-200W-24V-UNV		10.24" X 4.06" X 1.81"
PSHK-300W-24V-UNV		10.94" X 4.25" X 1.81"

COMPATIBLE TRANSFORMERS

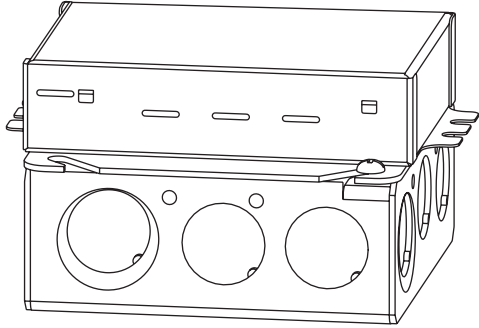

LUTRON 1% | 2 OR 3-WIRE DIMMING

LTEA4U1UKL-CV240

CLASS 2

4.0" x 1.5" x 4.0"

L3DA4U1UKL-CV240

CLASS 2

4.0" x 1.5" x 4.0"

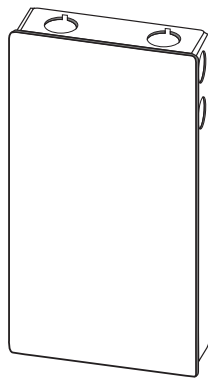

LUTRON 1%

PSDE-96W-24V-ECO

CLASS 2

10.5" x 3.0" x 2.0"