

LSM25

2.2W Indoor Flexible LED Strip

JOB NAME: _____
LOCATION: _____
QUOTE/REF#: _____

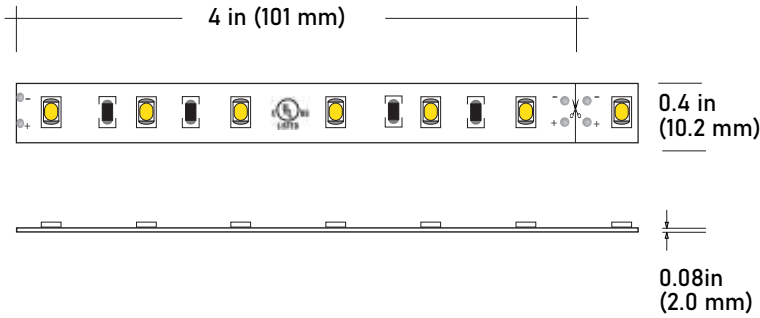

LSM25 is a dimmable flexible LED strip capable of delivering 185 Lumens of light output per Ft. Rated to last 50,000 hours making it an excellent replacement for halogen lighting. Its innovative low profile design makes it suitable for cove lighting, under cabinets, architectural and aesthetic enhancements. Its high lumen output, excellent color rendering, and color temperature options make perfect for most commercial or residential lighting applications.

SPECIFICATIONS

INPUT VOLTAGE	24V DC
POWER CONSUMPTION	2.2W per foot
LUMEN OUTPUT	185 Lumens per foot
NO. OF LEDs	18 LEDs per foot
BEAM ANGLE	120°
CRI	90+
DIMMING	MLV, ELV, 0-10 and TRIAC
MAXIMUM RUN LENGTH	30 Feet
FIELD CUTTABLE	Every 4 in (24V)
IP RATING	IP45 dry location (indoor)
LUMEN MAINTENANCE	50,000 hrs.
OPERATING TEMPERATURE	-40°F(-40°C)~+140°F(+60°C)
BINNING	1.5 Step Macadam Elipse
CERTIFICATIONS	UL listed, TITLE 24 JA8
DIMENSIONS	0.4" x 0.08 (width x height)

FEATURES

- 2.2W per Foot
- 185 Lumens
- 90+ CRI
- California TITLE 24 JA8 compliant
- Field cuttable
- Suitable for accent or ambient lighting
- Multiple CCT options available
- Superior COLOR RENDERING INDEX (CRI)
- UL Listed
- Dimmable with CORE Lighting dimmable drivers
- Approved for closet / storage space installation per NEC 410.16(A)(3) and 410.16(C)(5)

	COLOR TEMP	CRI	LUMEN/FT
--	------------	-----	----------



2700K	94	176
3000K	94	178
3500K	94	180
4000K	94	182
5000K	96	184
6000K	97	185



STANDARD ORDERING CODE

Model	Color Temp	Length	Voltage	Profile
LSM25	27K 2700K	16 16.4 Ft.	24 24 Volts	²See p3 for options
	30K 3000K	100 100 Ft.		
	35K 3500K	1XX per Ft.		
	40K 4000K			
	50K 5000K			
	60K 6000K			

NOTE:

- 1 =** Custom length per Ft. cuttable every 4"
- 2 =** Custom color finishes require powder coating. Allow 7 days lead time.

LSM25

2.2W Indoor Flexible LED Strip

COMPATIBLE ALUMINUM PROFILES

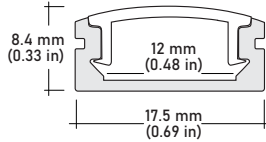

ALU-SF Surface
LENGTHS 39^{3/8} | 78^{7/8} | 84" | 98"
LENS Clear, Frosted
FINISH Silver | Black

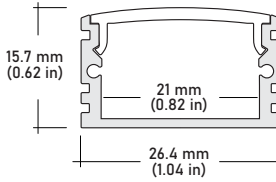

ALU-DS100 Surface Wide
LENGTHS 39^{3/8} | 78^{7/8} | 84"
LENS Clear, Frosted
FINISH Silver

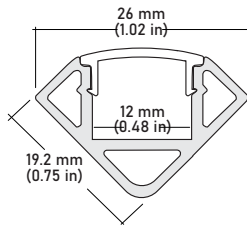

ALU-CN Surface, Corner
LENGTHS 39^{3/8} | 78^{7/8} | 84" | 96"
LENS Clear, Frosted
FINISH Silver | Black

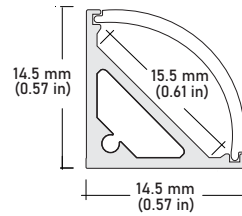

ALP-50C Surface, Corner
LENGTHS 49.25" | 84" | 98.5"
LENS Frosted
FINISH White | Black | Silver

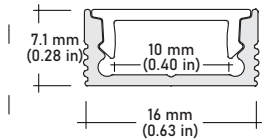

ALP-20 Surface
LENGTHS 49.25" | 84" | 98.5"
LENS Frosted
FINISH White | Black | Silver

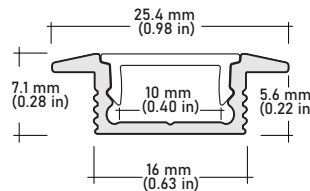

ALP-20R Recessed
LENGTHS 49.25" | 98.5"
LENS Frosted
FINISH White | Black | Silver

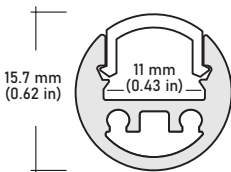

ALP-35 Surface
LENGTHS 48" | 96"
LENS Frosted
FINISH Silver

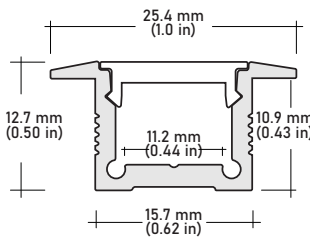

ALP-60R Recessed
LENGTHS 49.25" | 84" | 98.5"
LENS Frosted
FINISH White | Black | Silver

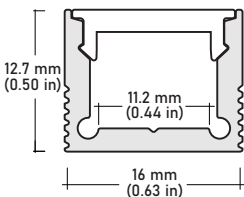

ALP-60 Surface
LENGTHS 49.25" | 98.5"
LENS Frosted
FINISH White | Black | Silver

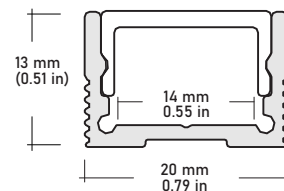

ALP-70 Surface
LENGTHS 49.25" | 84" | 98.5"
LENS Frosted
FINISH White | Black | Silver

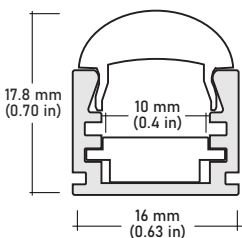

ALP-65 Surface
LENGTHS 49.25" | 84" | 98.5"
LENS Frosted
FINISH Silver
OPTICS 10° | 30° | 60°

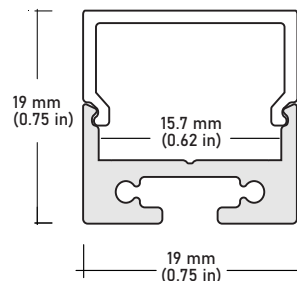

ALP-80 Surface, Suspended
LENGTHS 49.25" | 98.5"
LENS Frosted
FINISH Silver

COMPATIBLE TRANSFORMERS

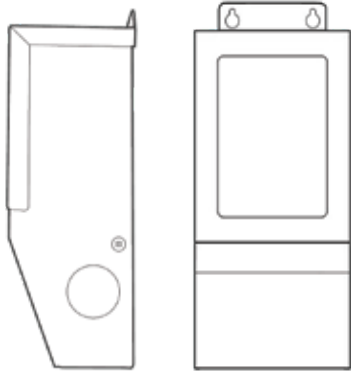

PSDM 24V SERIES | DIMMABLE MAGNETIC LOW VOLTAGE (MLV)

PSDM-20W-24V	CLASS 2	5.6" x 2" x 2.14"
PSDM-40W-24V	CLASS 2	5.6" x 2" x 2.14"
PSDM-60W-24V	CLASS 2	6.5" x 2.3" x 2.5"
PSDM-100W-24V	CLASS 2	6.5" x 2.3" x 2.5"
PSDM-150W-24V		9.8" x 3" x 3"
PSDM-192W-24V	CLASS 2	7.0" x 7.0" x 3.2"
PSDM-200W-24V		9.8" x 3" x 3"
PSDM-288W-24V	CLASS 2	9.8" x 4.2" x 3.5"
PSDM-300W-24V		7.0" x 7.0" x 3.2"

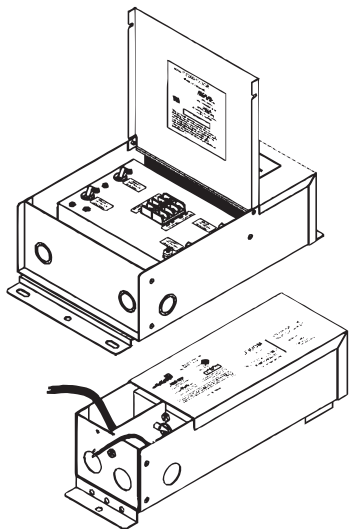

PSDH SERIES | HIGH PERFORMANCE MAGNETIC LOW VOLTAGE (MLV)

PSDH-48W-24V	CLASS 2	11.25" x 3.37" x 3.25"
PSDH-96W-24V	CLASS 2	11.25" x 3.37" x 3.25"
PSDH-288W-24V	CLASS 2	14.25" x 8.43" x 4.43"

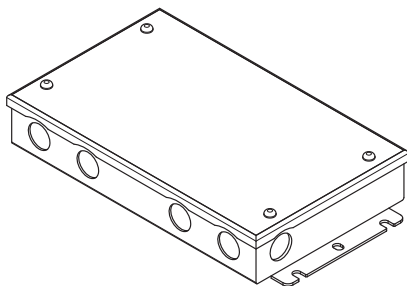

PSDL 24V SERIES | TRIAC DIMMABLE

PSDL-30W-24V	CLASS 2	6.5" x 3.63" x 1.03"
PSDL-60W-24V	CLASS 2	7.4" x 3.63" x 1.03"
PSDL-96W-24V	CLASS 2	8.67" x 3.67" x 1.62"
PSDL-150W-24V		8.67" x 3.67" x 1.62"
PSDL-192W-24V	CLASS 2	10.25" x 4.06" x 1.82"
PSDL-200W-24V		10.25" x 4.06" x 1.82"
PSDL-288W-24V	CLASS 2	10.25" x 4.06" x 1.82"
PSDL-300W-24V		10.25" x 4.06" x 1.82"

LSM25

2.2W Indoor Flexible LED Strip

COMPATIBLE TRANSFORMERS



PSDE SERIES | 0-10V DIMMING WITH JUNCTION BOX

PSDE-100W-24V-010-JB | CLASS 2 | 12.32" x 1.77" x 1.67"

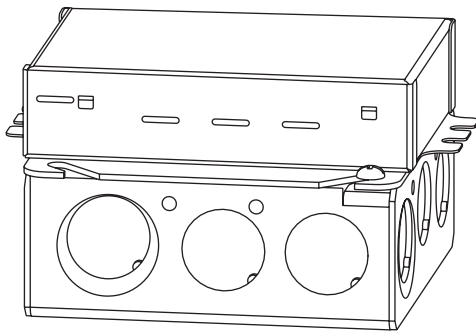
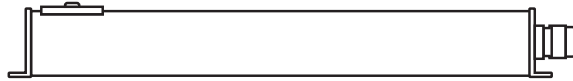

LUTRON 1% | 2 OR 3 WIRE DIMMING

LTEA4U1UKL-CV240 | CLASS 2 | 4.0" x 1.5" x 4.0"

L3DA4U1UKL-CV240 | CLASS 2 | 4.0" x 1.5" x 4.0"

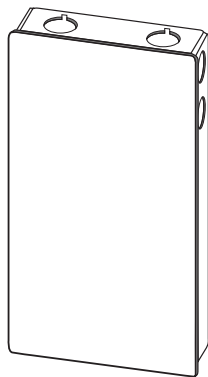

LUTRON 1%

PSDE-96W-24V-ECO | CLASS 2 | 10.5" x 3.0" x 2.0"

LSM25

2.2W Indoor Flexible LED Strip

COMPATIBLE CONNECTORS

HP PRO CONNECTORS | QUICK CONNECT SNAP-ON



LSA-HW8-HP	8" CONNECTOR	0.95" x 0.57" x 0.30"
LSA-HW24-HP	24" CONNECTOR	0.95" x 0.57" x 0.30"
LSA-HW60-HP	60" CONNECTOR	0.95" x 0.57" x 0.30"
LSA-HW120-HP	120" CONNECTOR	0.95" x 0.57" x 0.30"



LSA-EX3-HP	3" LINK	0.95" x 0.57" x 0.30"
LSA-EX8-HP	8" LINK	0.95" x 0.57" x 0.30"
LSA-EX24-HP	24" LINK	0.95" x 0.57" x 0.30"



LSA-DC24-HP	24" DC CONNECTOR	0.95" x 0.57" x 0.30"
--------------------	------------------	-----------------------

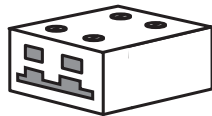

LSA-TB | SOLDERLESS LED STRIP / WIRE BLOCK CONNECTOR

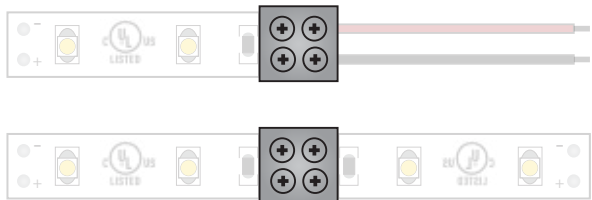

LSA-TB-HWC	6A HARDWIRE CONNECTOR	0.43" x 0.47" x 0.31"
LSA-TB-MC	STRIP TO STRIP COUPLING	0.43" x 0.47" x 0.31"
LSA-TB-HWP-10A	10A HARDWIRE CONNECTOR	0.55" x 0.55" x 0.35"