

LSM15

1.5W Indoor Flexible LED Strip

JOB NAME: _____
LOCATION: _____
QUOTE/REF#: _____

2 in (50 mm) - 12V
4 in (101 mm) - 24V

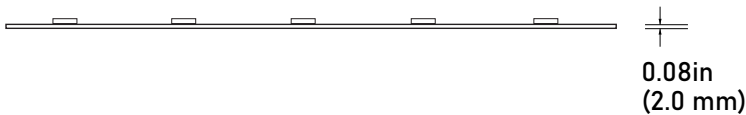
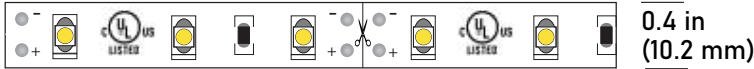







SPECIFICATIONS

INPUT VOLTAGE	12V and 24V DC
POWER CONSUMPTION	1.5 per foot
LUMEN OUTPUT	120 Lumens per Ft.
NO. OF LEDs	18 LEDs per foot
BEAM ANGLE	120°
CRI	95+
DIMMING	MLV, ELV, 0-10 and TRIAC
MAXIMUM RUN LENGTH	16.4 Ft. (12V strip) 24 Ft. (24V strip)
FIELD CUTTABLE	Every 2 in (12V) Every 4 in (24V)
IP RATING	IP54 dry location (indoor)
LUMEN MAINTENANCE	50,000 hrs.
OPERATING TEMPERATURE	-40°F(-40°C)~+140°F(+60°C)
BINNING	1.5 Step Macadam Elipse
CERTIFICATIONS	UL listed, TITLE 24 JA8
DIMENSIONS	0.4" x 0.08 (width x height)

FEATURES

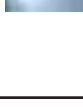
- 1.5W per Foot
- 120 Lumens
- 95+ CRI
- California TITLE 24 JA8 compliant
- Field cuttable
- Multiple CCT options available
- Superior COLOR RENDERING INDEX (CRI)
- Dimmable with CORE Lighting dimmable drivers
- Approved for closet / storage space installation per NEC 410.16(A)(3) and 410.16(C)(5)

	COLOR TEMP	CRI	LUMEN/FT
	2200K	94	102
	2400K	95	112
	2700K	98	115
	3000K	98	120
	3500K	97	121
	4000K	96	124
	5000K	95	126
	6000K	95	128



LSM15

1.5W Indoor Flexible LED Strip

STANDARD ORDERING CODE

Model	Color Temp	Length	Voltage	Profile
LSM15	22K 2200K	16 16.4 Ft.	12 12 Volts	² See p3 for options
	24K 2400K	100 100 Ft.	24 24 Volts	
	27K 2700K	1XX per Ft.		
	30K 3000K			
	35K 3500K			
	40K 4000K			
	50K 5000K			
	60K 6000K			
	RD Red			
	BL Blue			
	GR Green			
	PK Pink			
	PR Purple			
AM Amber				
OR Orange				

NOTE:

- 1 =** Custom length per Ft.
12V strip cuttable every 2"
24V strip cuttable every 4"
- 2 =** Custom color finishes require powder coating. Allow 7 days lead time.

COMPATIBLE PROFILES

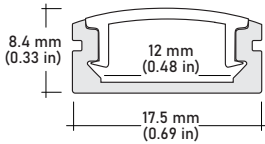

ALU-SF Surface
LENGTHS 39^{3/8}" | 78^{7/8}" | 84" | 98"
LENS Clear, Frosted
FINISH Silver | Black

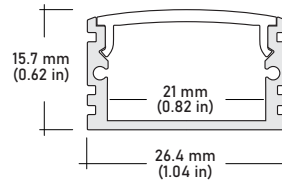

ALU-DS100 Surface Wide 39^{3/8}"
LENGTHS | 78^{7/8}" | 84"
LENS Clear, Frosted
FINISH Silver

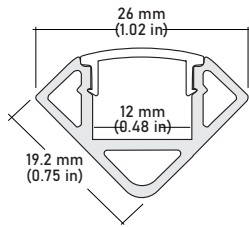

ALU-CN Surface, Corner 39^{3/8}" |
LENGTHS 78^{7/8}" | 84" | 96"
LENS Clear, Frosted
FINISH Silver | Black

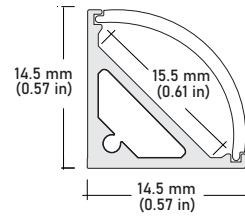

ALP-50C Surface, Corner
LENGTHS 49.25" | 84" | 98.5"
LENS Frosted
FINISH White | Black | Silver

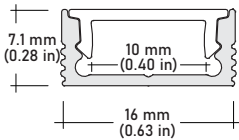

ALP-20 Surface
LENGTHS 49.25" | 84" | 98.5"
LENS Frosted
FINISH White | Black | Silver

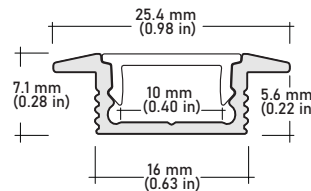

ALP-20R Recessed
LENGTHS 49.25" | 98.5"
LENS Frosted
FINISH White | Black | Silver

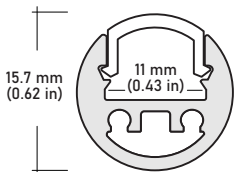

ALP-35 Surface
LENGTHS 48" | 96"
LENS Frosted
FINISH Silver

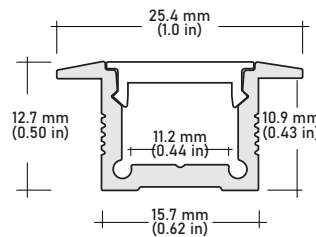

ALP-60R Recessed
LENGTHS 49.25" | 84" | 98.5"
LENS Frosted
FINISH White | Black | Silver

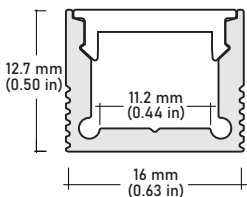

ALP-60 Surface
LENGTHS 49.25" | 84" | 98.5"
LENS Frosted
FINISH White | Black | Silver

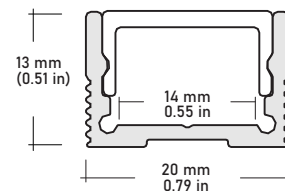

ALP-70 Surface
LENGTHS 49.25" | 84" | 98.5"
LENS Frosted
FINISH White | Black | Silver

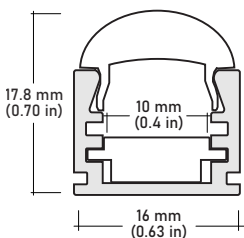

ALP-65 Surface
LENGTHS 49.25" | 84" | 98.5"
LENS Frosted
FINISH Silver
OPTICS 10° | 30° | 60°

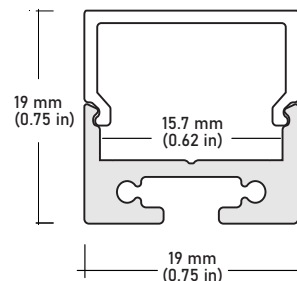

ALP-80 Surface, Suspended
LENGTHS 49.25" | 98.5"
LENS Frosted
FINISH Silver

COMPATIBLE TRANSFORMERS

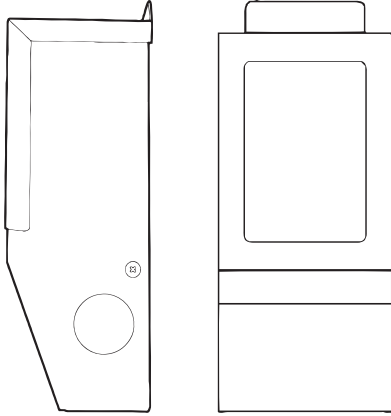

PSDM SERIES | DIMMABLE MAGNETIC LOW VOLTAGE (MLV)

PSDM-20W-12V	CLASS 2	5.6" x 2" x 2.14"
PSDM-40W-12V	CLASS 2	5.6" x 2" x 2.14"
PSDM-60W-12V	CLASS 2	6.5" x 2.3" x 2.5"
PSDM-100W-12V	CLASS 2	9.8" x 3" x 3"
PSDM-150W-12V		9.8" x 3" x 3"
PSDM-180W-12V		9.8" x 3" x 3"
PSDM-200W-12V		9.8" x 3" x 3"
PSDM-300W-12V		9.8" x 4.2" x 3.5"

PSDM-20W-24V	CLASS 2	5.6" x 2" x 2.14"
PSDM-40W-24V	CLASS 2	5.6" x 2" x 2.14"
PSDM-60W-24V	CLASS 2	6.5" x 2.3" x 2.5"
PSDM-100W-24V	CLASS 2	6.5" x 2.3" x 2.5"
PSDM-150W-24V		9.8" x 3" x 3"
PSDM-192W-24V	CLASS 2	7.0" x 7.0" x 3.2"
PSDM-200W-24V		9.8" x 3" x 3"
PSDM-288W-24V	CLASS 2	9.8" x 4.2" x 3.5"
PSDM-300W-24V		7.0" x 7.0" x 3.2"

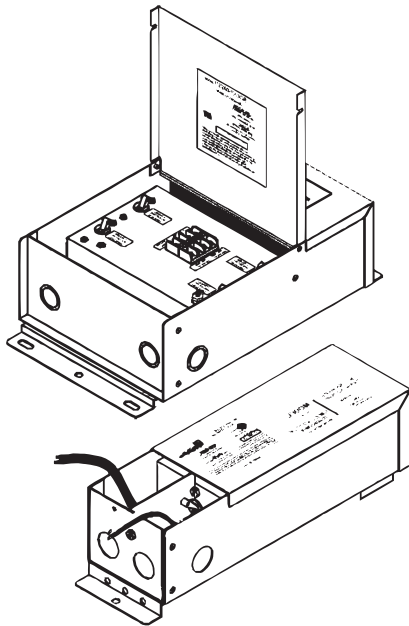

PSDH SERIES | HIGH PERFORMANCE MAGNETIC LOW VOLTAGE (MLV)

PSDH-48W-24V	CLASS 2	11.25" x 3.37" x 3.25"
PSDH-96W-24V	CLASS 2	11.25" x 3.37" x 3.25"
PSDH-288W-24V	CLASS 2	14.25" x 8.43" x 4.43"

COMPATIBLE TRANSFORMERS

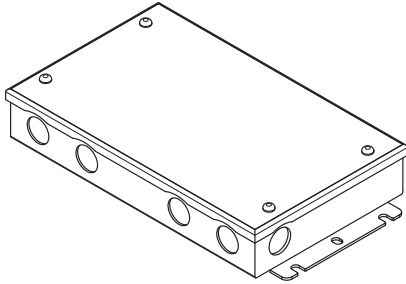

PSDL SERIES | TRIAC DIMMABLE

PSDL-30W-12V	CLASS 2	6.5"x 3.63"x 1.03"
PSDL-60W-12V	CLASS 2	7.4"x 3.63"x 1.03"
PSDL-100W-12V	CLASS 2	8.67"x 3.67"x 1.62"
PSDL-120W-12V		8.67"x 3.67"x 1.62"
PSDL-150W-12V		10.25"x 4.06"x 1.82"
PSDL-200W-12V		10.25"x 4.06"x 1.82"
PSDL-300W-12V		10.25"x 4.06"x 1.82"

PSDL-30W-24V	CLASS 2	6.5"x 3.63"x 1.03"
PSDL-60W-24V	CLASS 2	7.4"x 3.63"x 1.03"
PSDL-96W-24V	CLASS 2	8.67"x 3.67"x 1.62"
PSDL-150W-24V		8.67"x 3.67"x 1.62"
PSDL-192W-24V	CLASS 2	10.25"x 4.06"x 1.82"
PSDL-200W-24V		10.25"x 4.06"x 1.82"
PSDL-288W-24V	CLASS 2	10.25"x 4.06"x 1.82"
PSDL-300W-24V		10.25"x 4.06"x 1.82"

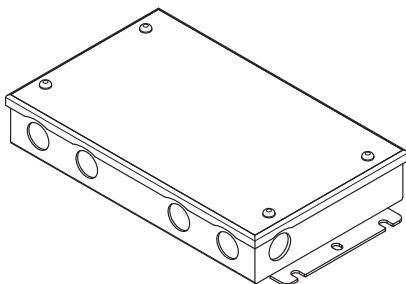

PSHK SERIES | NON-DIMMING W/ JUNCTION BOX

PSHK-30W-24V-UNV	CLASS 2	6.5" X 3.6" X 1.02"
PSHK-60W-24V-UNV	CLASS 2	7.4" X 3.62" X 1.02"
PSHK-96W-24V-UNV	CLASS 2	8.66" X 3.66" X 1.61"
PSHK-150W-24V-UNV		10.24" X 4.06" X 1.81"
PSHK-200W-24V-UNV		10.24" X 4.06" X 1.81"
PSHK-300W-24V-UNV		10.94" X 4.25" X 1.81"

COMPATIBLE TRANSFORMERS



PSDE SERIES | 0-10V DIMMING W/ JUNCTION BOX

PSDE-100W-24V-010-JB CLASS 2 12.32" x 1.77" x 1.67"

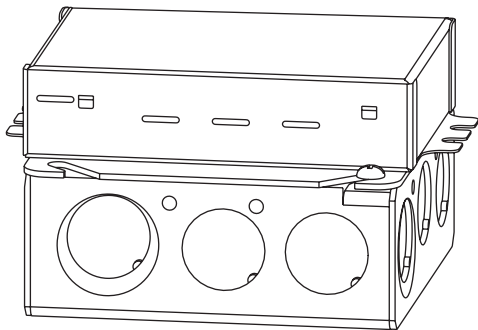
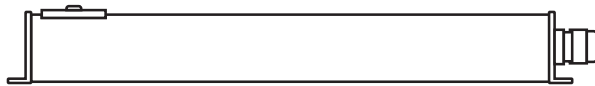

LUTRON 1% | 2 OR 3-WIRE DIMMING

LTEA4U1UKL-CV240 CLASS 2 4.0" x 1.5" x 4.0"

L3DA4U1UKL-CV240 CLASS 2 4.0" x 1.5" x 4.0"

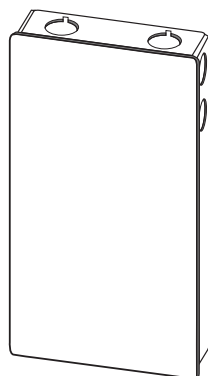

LUTRON 1%

PSDE-96W-24V-ECO CLASS 2 10.5" x 3.0" x 2.0"

COMPATIBLE TRANSFORMERS

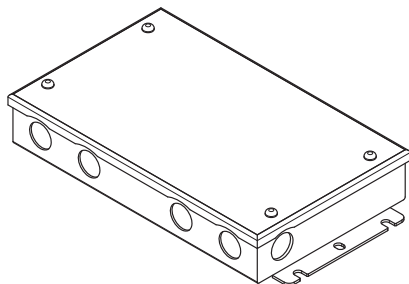

PSVT SERIES | 0-10V DIMMING DRIVER

PSVT-60W-24V	CLASS 2	7.4" X 3.72" X 1.57"
PSVT-96W-24V	CLASS 2	8.66" X 3.72" X 1.57"
PSVT-200W-24V		10.24" X 4.13" X 1.77"
PSVT-288W-24V	CLASS 2	11.85" X 4.25" X 1.81"
PSVT-300W-24V		10.94" X 4.33" X 1.77"

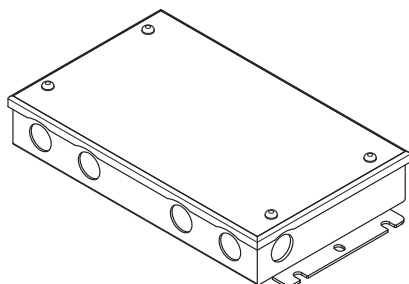

PSRX SERIES | 4-in-1 DIMMING DRIVER W/ JUNCTION BOX

PSRX-30W-12V-UNV	CLASS 2	6.5" X 3.7" X 1.57"
PSRX-60W-12V-UNV	CLASS 2	7.4" X 3.72" X 1.57"
PSRX-150W-12V-UNV		10.24" X 4.13" X 1.77"
PSRX-30W-24V-UNV	CLASS 2	6.5" X 3.7" X 1.57"
PSRX-60W-24V-UNV	CLASS 2	7.4" X 3.72" X 1.57"
PSRX-96W-24V-UNV	CLASS 2	10.24" X 4.13" X 1.77"
PSRX-150W-24V-UNV		10.24" X 4.13" X 1.77"
PSRX-200W-24V-UNV		10.24" X 4.13" X 1.77"
PSRX-300W-24V-UNV		10.94" X 4.33" X 1.77"

QUICK CONNECTORS

HP PRO CONNECTORS | QUICK CONNECT SNAP-ON

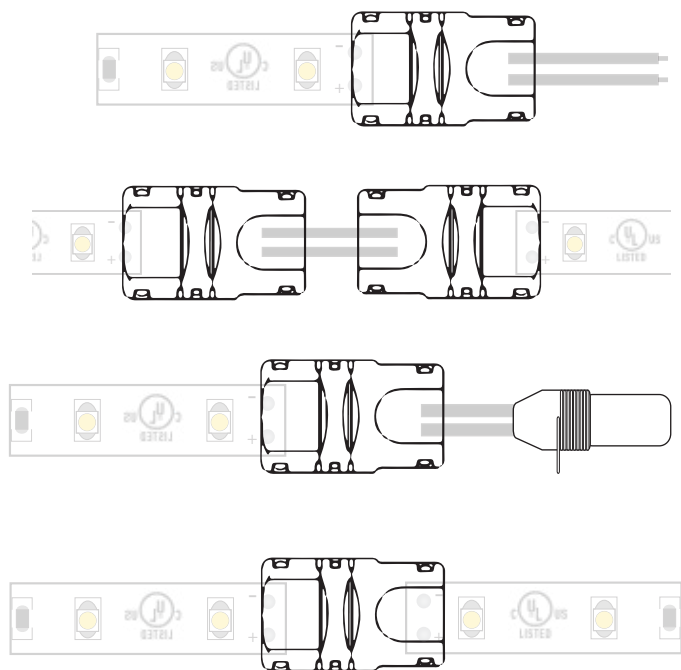

LSA-HW8-HP 8" CONNECTOR
LSA-HW24-HP 24" CONNECTOR
LSA-HW60-HP 60" CONNECTOR
LSA-HW120-HP 120" CONNECTOR

LSA-EX3-HP 3" LINK
LSA-EX8-HP 8" LINK
LSA-EX24-HP 24" LINK

LSA-DC24-HP 24" DC CONNECTOR

LSA-MC-HP MINI COUPLING

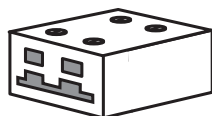

LSA-TB | SOLDERLESS LED STRIP / WIRE BLOCK CONNECTOR

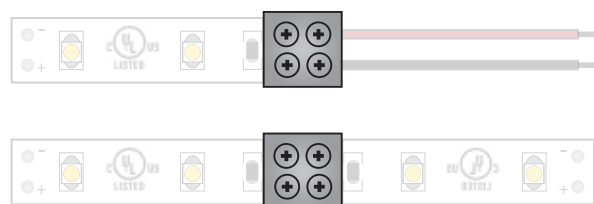

LSA-TB-HWC 6A HARDWIRE CONNECTOR

LSA-TB-MC STRIP TO STRIP COUPLING

LSA-TB-HWP-10A 10A HARDWIRE CONNECTOR