

SPECIFICATION SHEET

JOB NAME: _____
 LOCATION: _____
 QUOTE/REF#: _____



ROC LIGHTING introduces its Architectural Grade outdoor lighting luminaires. Machined from military grade solid aluminum, and treated with a special chromation process, ROC fixtures are designed to withstand the harshest environments, and provide a long lasting durable light source. These premium outdoor lighting fixtures a great source of light in uplight or downlight applications such as landscape lighting, tree-mounted lighting or wall accent/security lighting. Rated for Wet Location.

FEATURES

- Architectural Grade Outdoor Luminaire
- Military Grade Solid Aluminum
- Integrated LED
- Suitable for landscape, tree-mounted / accent lighting
- Outdoor / Wet Location

SPECIFICATIONS

LIGHT SOURCE	7W High Power LED
LUMENS	500 lumens (CW) / 450 lumens (WW)
CRI	75 CRI (WW) / 80 CRI (WW)
COLOR TEMPERATURE	27K / 30K / 40K
BEAM ANGLE	25° / 38°
LUMEN MAINTENANCE	50,000 hours
DIMMING	Dimmable
VOLTAGE	12V AC/DC
RATING	Dry / Damp / Wet
MOUNTING	1/2" NPS Thread
TRANSFORMER	Required (not included)
MATERIAL	Precision Machined Aluminum
WARRANTY	3-Year Limited

DIMENSIONS

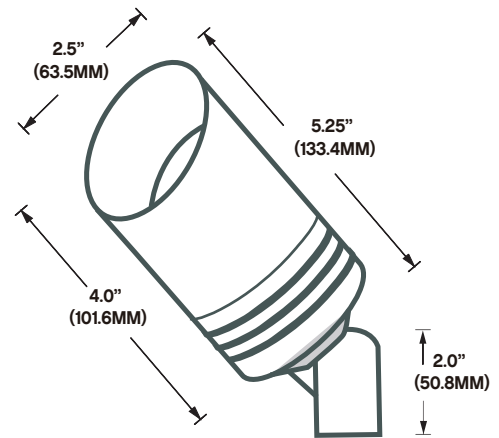

ORDERING GUIDE EX: FL401-BZ-STD-L1

FL430				
MODEL	COLOR TEMPERATURE	BEAM ANGLE	FINISH	CAP STYLE
	27K - 2700K 30K - 3000K 40K - 4000K	25 - 25° 38 - 38°	BK - Black BZ - Bronze SA - Silver Anodized	STD - Standard SAG - Short Angle Bezel LAG - Long Angle Bezel

CAP STYLE OPTIONS

STD | Standard Bezel

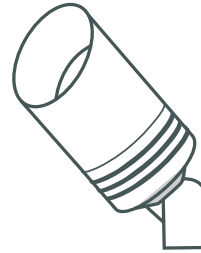

SAG | Short Angle Bezel

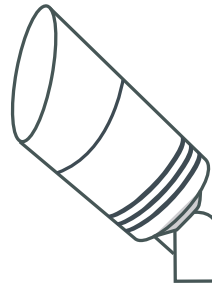

LAG | Long Angle Bezel

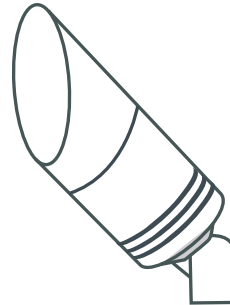

CAP STYLE OPTIONS

CP-301

FINISH OPTIONS

- | | |
|---------------------------|------------------------|
| ■ 3/0 Flat Aluminum Plate | ■ SA - Silver Anodized |
| ■ Single Mounting Hole | ■ BK - Black |
| ■ 4.75" Round Diameter | ■ BZ - Bronze |
| ■ 1/2" NPS Thread | ■ WH - White |

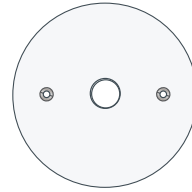

CP-302

FINISH OPTIONS

- | | |
|---------------------------|------------------------|
| ■ 3/0 Flat Aluminum Plate | ■ SA - Silver Anodized |
| ■ Double Mounting Hole | ■ BK - Black |
| ■ 4.75" Round Diameter | ■ BZ - Bronze |
| ■ 1/2" NPS Thread | ■ WH - White |

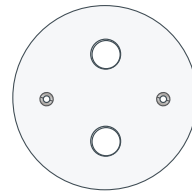

CP-401

FINISH OPTIONS

- | | |
|---------------------------|------------------------|
| ■ 4/0 Flat Aluminum Plate | ■ SA - Silver Anodized |
| ■ Single Mounting Hole | ■ BK - Black |
| ■ 4.75" Round Diameter | ■ BZ - Bronze |
| ■ 1/2" NPS Thread | ■ WH - White |

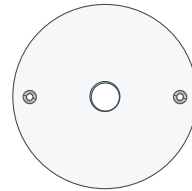

CP-402

FINISH OPTIONS

- | | |
|---------------------------|------------------------|
| ■ 4/0 Flat Aluminum Plate | ■ SA - Silver Anodized |
| ■ Double Mounting Hole | ■ BK - Black |
| ■ 4.75" Round Diameter | ■ BZ - Bronze |
| ■ 1/2" NPS Thread | ■ WH - White |

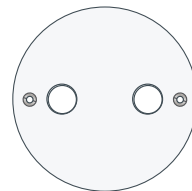

CP-403

FINISH OPTIONS

- | | |
|---------------------------|------------------------|
| ■ 4/0 Flat Aluminum Plate | ■ SA - Silver Anodized |
| ■ Triple Mounting Hole | ■ BK - Black |
| ■ 4.75" Round Diameter | ■ BZ - Bronze |
| ■ 1/2" NPS Thread | ■ WH - White |

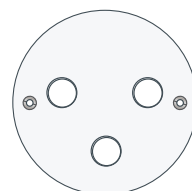

ACCESSORIES

MB-100 | Tree Surface Canopy

- 1/2" NPS Thread
- 1" Height
- 2 1/4" diameter

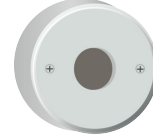

MB-200 | Mini Surface Wiring Box

- 1/2" NPS Thread
- 1 5/8" Height
- 2 1/4" diameter

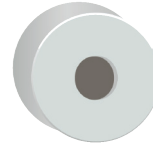

MB-400 | Round Surface Canopy

- Mounting onto 4/0 or 3/0 boxes
- 1 1/4" Height
- 4 3/4" diameter



MB-500 | Round Surface Canopy

- Surface Mount 1/2" NPS Thread
- 1 1/4" Height
- 4 3/4" diameter



MP-100 | Composite Mounting Spike

- 1/2" Female Thread
- 8 3/4" Height
- 2" diameter

