

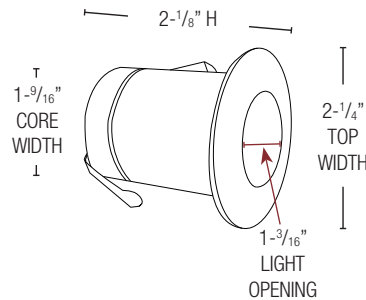

PROJECT	DATE
TYPE	CATALOG #

CORE FLAT TOP

SD-610B

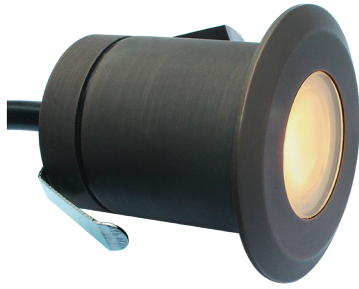

KEY FEATURES

- VERSATILE 4-IN-ONE CORE LIGHT
- IDEAL FOR IN GROUND, STEP/DECK, WALL AND CEILING APPLICATIONS
- CAST BRASS
- TEMPERED, SHOCK AND HEAT RESISTENT LENS
- INCLUDES CONCRETE POUR SLEEVE
- INSTALL WITH SOFT LIGHT SPREAD (T3) OR DIRECT PROJECTION (MR8) LED OPTIONS

PRODUCT SPECIFICATIONS

MATERIAL	CAST BRASS
LENS	FROST TEMPERED
SOCKET	BI-PIN
LAMP	T3 OR MR8 (MAX 20W)
VOLTAGE	11-13V AC/DC
LEAD WIRE	3 FT
PROJECTION	UP TO 20 FT* (MR8)
PROJECTION	2-3 FT LOW LEVEL IN DIRECT (T3)

APPLICATIONS

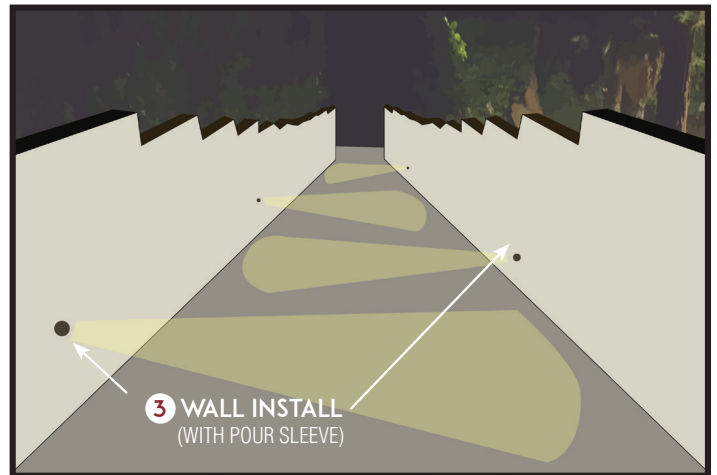
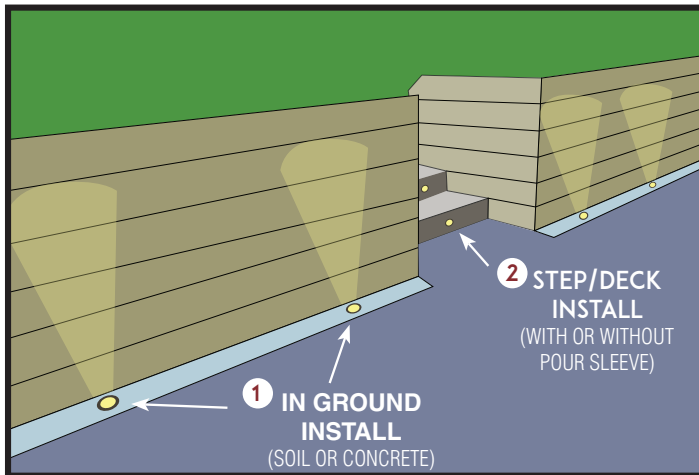

- 1 IN GROUND INSTALL** - INSTALL IN SOIL OR CONCRETE (*POUR SLEEVE*) TO LIGHT UP COLUMNS, WALLS OR SMALL LANDSCAPE FEATURES (*MR8*). USE SOFT LED (*T3*) TO CREATE A MARKER ACCENT LIGHT WITHOUT DIRECT GLARE.
- 2 STEP/DECK INSTALL** - USE FOR LOW PROFILE STEP/DECK INSTALLS (*Sits 5mm above grade*) (*STANDARD 2" HOLE DRILL*)
- 3 WALL INSTALL** - INSTALL LOW TO MID LEVEL HEIGHT IN CONCRETE WALLS TO PROVIDE A DIRECT PROJECTION (*MR8*) LIGHT EFFECT. (*STANDARD 2" HOLE DRILL*)
- 4 CEILING INSTALL** - DRILL 2" HOLE TO INSTALL IN CEILING FOR DOWNLIGHT APPLICATION. (*NOT SHOWN*)

NOTE: THE FIXTURE IS NOT FLUSH TO GRADE. INSTALL WITH *CAUTION* IN HIGH TRAFFIC AREAS. (*Sits 5mm above grade*)

* **20 FT PROJECTION:** USING LED-MR8 LAMP



PROJECT	DATE
TYPE	CATALOG #

**STEP 1
FIXTURE CONFIGURATION**



INCLUDES

CORE LIGHT



**8" PVC POUR SLEEVE
(FIELD CUTTABLE)**

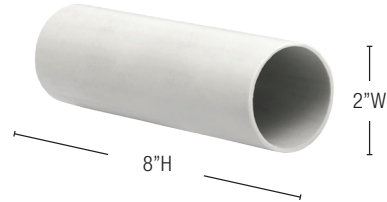

SPECIFYING YOUR LED

For soft light spread specify **SOFT LED (T3)** and for projected light illumination specify **DIRECT PROJECTED LED (MR8)**

**STEP 2 (SOFT LED)
LED LAMP CONFIGURATION**

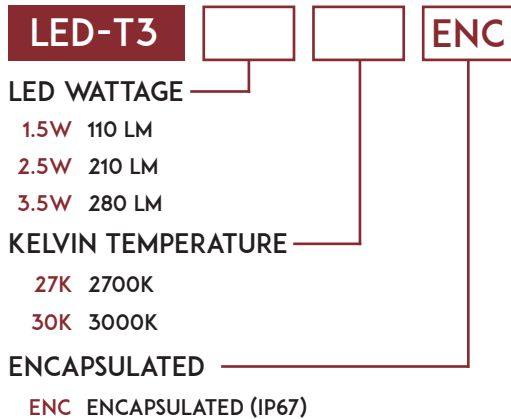

**STEP 2 (DIRECT PROJECTED LED)
LED LAMP CONFIGURATION**

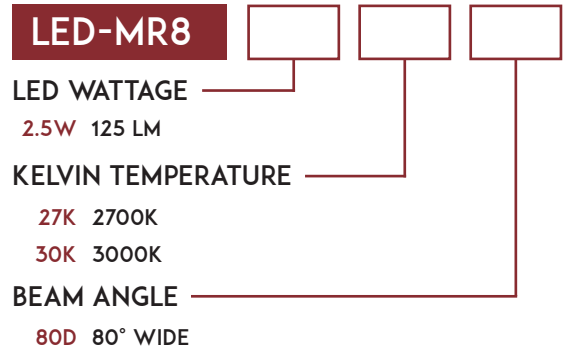

*PRIMARY SIDE DIMMING: Requires LED magnetic low voltage (MLV) or LED electronic low voltage (ELV) dimmable transformer and compatible LED dimmer (MLV OR ELV)
 + Fully tested with Lutron Diva (DVLV-600P) dimmer and Lightcraft dimmable transformers
 + Lumens calculated at 3000K (-5% for 2700K)



PROJECT	DATE
TYPE	CATALOG #

INSTALLATION INSTRUCTIONS

Pre-Installation Guidelines

All In Ground fixtures must be installed to drain water away from the fixture. We recommend using pea gravel or sand as this will allow for superior drainage.

1 DIG HOLE & PLACE WIRE

GROUND INSTALL

- Dig hole(s) at the location of each fixture. Remove enough soil to install fixture allowing 8" of pea gravel or sand below & on the sides of fixture for drainage.

Recommended

Dig trench for flexible conduit or PVC running to the fixture. This will allow you to easily service the fixture.

- Feed your low voltage cable from the main line to where you are placing your pour sleeve.
- Place pour sleeve into the hole.

2 FILL HOLE

- Fill hole with pea gravel to ensure proper fit and drainage.

Concrete Install

Fill pea gravel allowing 2" for concrete pour. Pour concrete using standard masonry techniques.

3 SECURE WIRE CONNECTIONS & TEST

- Cut PVC sleeve to size. Allow enough length for sealed wire connection.
- Connect your low voltage cable from your main line to the fixture core using silicone filled wire connectors.
- Install LED lamp (LED MR8 or LED T3).
- Test to make sure your fixture is receiving power prior to the next step.

4 SEAL CORE & INSERT TO SLEEVE

- Once the fixture core is wired, place into the pour sleeve.
- Power your fixture.