

IMPORTANT SAFEGUARDS

When using electrical equipment, basic safety precautions should always be followed, including the following:

1. READ AND FOLLOW ALL SAFETY INSTRUCTIONS.

2. Do not use outdoors.
3. Do not mount near gas or electric heaters.
4. Do not let power supply cords touch hot surfaces.
5. Use caution when servicing batteries. Avoid possible shorting.
6. Equipment should be mounted in locations and at heights where it will not readily be subjected to tampering by unauthorized personnel.
7. The use of accessory equipment is not recommended by the manufacturer as it may cause an unsafe condition.
8. Do not use this equipment for other than intended use.
9. Before wiring to power supply and during servicing or relamping, turn off AC power at fuse or circuit breaker.
10. Disconnect AC power and unplug battery before servicing.
11. When relamping, only use lamps specified in the fixture.
12. Battery in this unit may not be fully charged. After electricity is hooked up to unit, let the battery charge up for at least 24hrs., then normal operation of this unit should take effect.
13. All Servicing should be performed by qualified personnel.

SAVE THESE INSTRUCTIONS

INSTALLATION INSTRUCTIONS

BACK MOUNTING

1. Drill 3/8" hole into the center hole of back plate(3). (recommended) Drill 1/4" holes into oblong holes on back plate (3) that correspond to junction box (10) being used.
2. Feed lamp leads through center hole and make the proper connections. If using 120VAC, connect the black and white leads to the building utility. If using 277VAC, connect orange and white leads to the building utility. In all cases use standard wire nuts in connection of the leads. Also if using emergency unit make sure to snap battery connector together.
3. Feed excess wire into junction box and secure back plate (3) to junction box (10).
4. Snap in arrows (5) to SALIDA panel (2) as required , storing unused arrows in a safe place. Snap supplied cover (4) into ceiling and side mounting holes. Then snap SALIDA panel (2) to housing top first and then bottom.

SIDE MOUNTING

1. Attach crossbar (11) to junction box (10).
2. Feed lamp leads through side hole, making sure to secure wire into wire guides found at the edges of the sign.
3. Attach sign to canopy (7) by inserting canopy into sign at an angle, then twist to secure.
4. Make the proper lamp lead connections. If using 120VAC, connect the black and white leads to the building utility. If using 277VAC, connect orange and white leads to the building utility. In all cases use standard wire nuts in connection of the leads. Also if using emergency unit make sure to snap battery connector together. (In attaching wires you may use the enclosed "holding wire" (13) for assistance. See Diagram.)
5. Push excess wire into junction box and secure back plate (3) to junction box (10). Then align holes in canopy with those in crossbar (11). Using screws and washers supplied, tighten canopy to crossbar so that canopy is securely fastened and tight against wall.
6. Snap in arrows (5) to SALIDA panel (2) as required, storing unused arrows in a safe place. Snap supplied covers(4) into ceiling mounting hole. The snap SALIDA panel (2) to housing top first and then bottom.

CEILING MOUNTING

1. Attach crossbar (11) to junction box (10).
2. Feed lamp leads through top hole, making sure to secure wire into wire guides found at the edges of the sign.
3. Attach sign to canopy (7) by inserting canopy into sign at an angle, then twist to secure.
4. Make the proper lamp lead connections. If using 120VAC, connect the black and white leads to the building utility. If using 277VAC, connect orange and white leads to the building utility. In all cases use standard wire nuts in connection of the leads. Also if using emergency unit make sure to snap battery connector together. (In attaching wires you may use the enclosed "holding wire" (13) for assistance. See Diagram.)
5. Push excess wire into junction box and then align holes in canopy with those in crossbar. Using screws and washers supplied, tighten canopy to crossbar so that canopy is securely fastened and tight against ceiling.
6. Snap in arrows (5) to SALIDA panel (2) as required, storing unused arrows in a safe place. Snap covers (4) to side mounting hole. Then snap SALIDA panel (2) to housing top first and then bottom.

INSTALLATION INSTRUCTIONS (1)

BACK MOUNTING

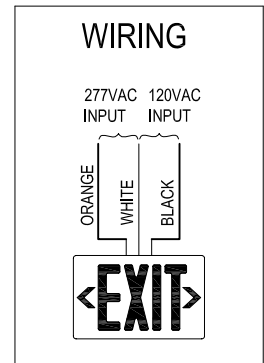
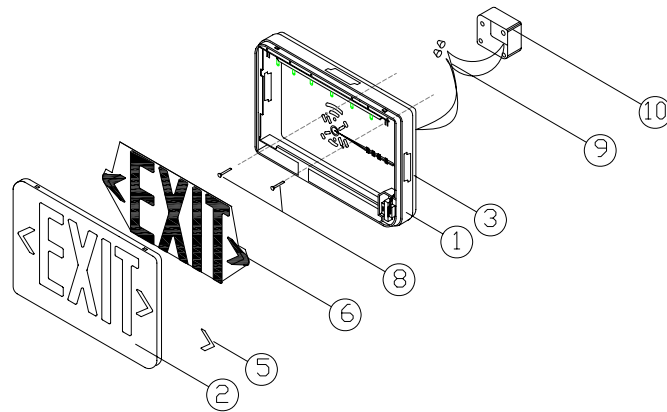

SIDE MOUNTING

PARTS DESCRIPTION

- 1) Plastic housing
- 2) EXIT panel
- 3) Back plate
- 4) Mounting hole cover
- 5) Snap-in Directional Arrow
- 6) Red or Green diffuser
- 7) Canopy
- 8) Canopy screws
- 9) Wire nuts
- 10) Junction box (Building utility)
- 11) Crossbar
- 12) Crossbar screws (not provided)
- 13) Holding wire

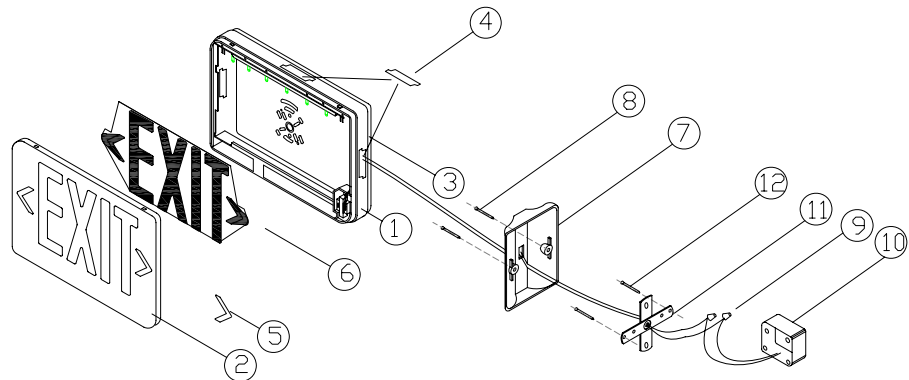

CEILING MOUNTING

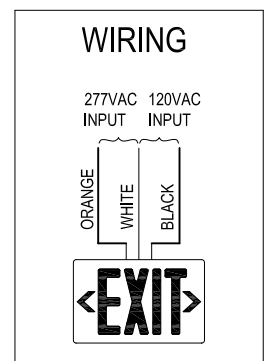
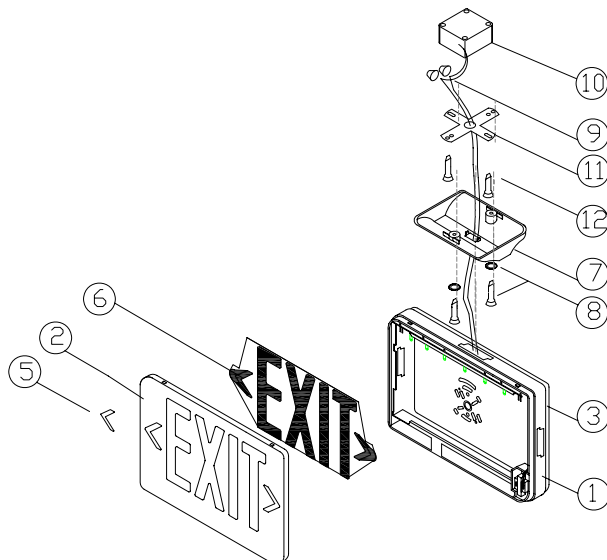

INSTALLATION INSTRUCTIONS (2)

ASSEMBLING : CANOPY + HOUSING

Insert canopy into housing at a 20 degree angle and twist.
Quick Snap is now locked firmly.

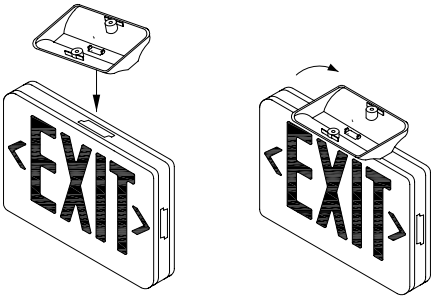

CAUTION

Trying to remove canopy after it is locked in place may cause damage.

OPERATING MANUAL

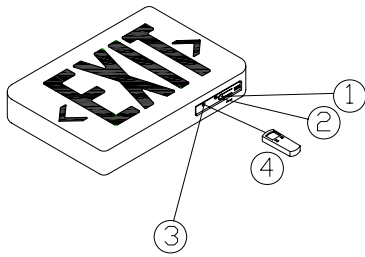

USING REMOTE CONTROL

When using remote control, EXIT SIGN must be in line of sight.

1. Manual battery test switch
2. Red LED (Indicates normal operation)
3. Remote sensor (optional)
4. Remote controller (optional)

CAUTION

Battery connector is shipped disconnected, it must be connected after installation.

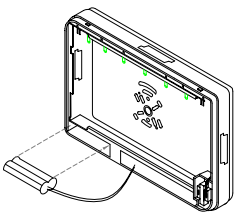

OPENNING EXIT PANEL

When opening EXIT panel, please insert screw driver into the slots at the bottom. Then push and down smoothly.

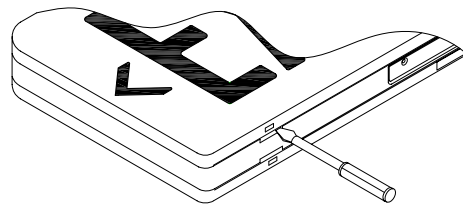

USING HOLDING WIRE

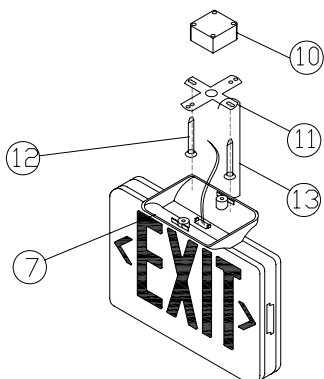

Hands free holding wire supports sign during wiring.

PARTS DESCRIPTION

- 7) Canopy
- 10) Junction box (Building utility)
- 11) Crossbar
- 12) Crossbar screws
- 13) Holding wire