

Installation Instructions

NQ22

Quartz LED Downlight with Selectable Lumens & Selectable CCT

READ PRIOR TO ATTEMPTING INSTALLATION
 ALWAYS TURN OFF MAIN POWER BEFORE INSTALLATION
 INSTALLATION SHOULD BE CARRIED OUT BY YOUR LOCAL ELECTRICIAN

⚠ WARNING - Risk of fire or electric shock. LED Retrofit Kit installation requires knowledge of luminaires electrical systems. If not qualified, do not attempt installation. Contact a qualified electrician.

⚠ AVERTISSEMENT - Risque d'incendie ou d'électrocution. L'installation du kit de rénovation LED nécessite la connaissance des systèmes électriques des luminaires. Si vous n'êtes pas qualifié, n'essayez pas installation. Contactez un électricien qualifié.

⚠ WARNING - Risk of fire or electric shock. Install this kit only in luminaires that have the construction features and dimensions shown in the photographs and / or drawings and where the input rating of the retrofit kit does not exceed the input rating of the luminaire.

⚠ AVERTISSEMENT - Risque d'incendie ou d'électrocution. Installez ce kit uniquement dans les luminaires qui ont les caractéristiques de construction et les dimensions indiquées sur les photos et / ou des dessins et où la puissance d'entrée du kit de mise à niveau ne dépasse pas la valeur d'entrée du luminaire.

⚠ WARNING - To prevent wiring damage or abrasion, do not expose wiring to edges of sheet metal or other sharp objects.

DO NOT MAKE OR ALTER ANY OPEN HOLES IN AN ENCLOSURE OF WIRING OR ELECTRICAL COMPONENTS DURING KIT INSTALLATION.

⚠ AVERTISSEMENT - Pour éviter tout dommage ou abrasion du câblage, n'exposez pas le câblage aux bords de la tôle ou d'autres objets pointus.

NE PAS FAIRE OU MODIFIER LES TROUS OUVERTS DANS UNE BOÎTE DE CÂBLAGE OU DE COMPOSANTS ÉLECTRIQUES PENDANT L'INSTALLATION DU KIT.

THIS DEVICE IS NOT INTENDED FOR USE WITH EMERGENCY EXITS

NE CONVIENT PAS AUX SORTIES DE SECOURS

THE RETROFIT KIT IS ACCEPTED AS A COMPONENT OF A LUMINAIRE WHERE THE SUITABILITY OF THE COMBINATION SHALL BE DETERMINED BY AUTHORITIES HAVING JURISDICTION.

PRODUCT MUST BE INSTALLED BY A QUALIFIED ELECTRICIAN IN ACCORDANCE WITH THE APPLICABLE AND APPROPRIATE ELECTRICAL CODES. THE INSTALLATION GUIDE DOES NOT SUPERSEDE LOCAL OR NATIONAL REGULATIONS FOR ELECTRICAL INSTALLATIONS.

LE KIT DE RÉTROFIT EST ACCEPTÉ COMME COMPOSANT D'UN LUMINAIRE O L'ADÉQUATION DE LA COMBINAISON EST DÉTERMINÉE PAR LES AUTORITÉS AYANT JURIDICITION. LE PRODUIT DOIT ÊTRE INSTALLÉ PAR UN ÉLECTRICIEN QUALIFIÉ SELON L'APPLICABLE ET APPROPRIÉ CODES ÉLECTRIQUES. LE GUIDE D'INSTALLATION NE REMPLACE PAS LES RÉGLEMENTATIONS LOCALES OU NATIONALES POUR LES INSTALLATIONS ÉLECTRIQUES

ETL CLASSIFIED



PACKAGING CONTENTS

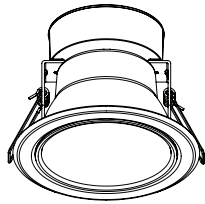

LED Luminaire

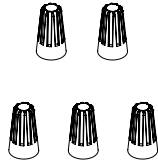

(5) Wire Nuts, Twist-Lock



CEILING OPENING DIMENSIONS



NQ22-41TWTW	4-3/4" (120.5mm)
NQ22-61TWTW	6-1/4" (158.8mm)
NQ22-81TWTW	7-7/8" (199.6mm)

NEW CONSTRUCTION INSTALLATION

1. Turn off power before installation.
2. Before installing the fixture, set the desire color temperature and wattage located on the top of the luminaire. (Figure 1)
3. Cut the opening on the ceiling. Refer to the table in "Ceiling Opening Dimensions".
4. Connect the luminaire to a supply box. (Figure 2) Refer to "Electrical Connections".

CAUTION: Do not place supply box directly above the luminaire.

5. Lift the spring clips on the luminaire and insert the luminaire into the ceiling. (Figure 3)
6. Installation complete, turn on power.

CAUTION: If the luminaire does not turn on within five seconds, turn off power. Remove the luminaire from the ceiling and carefully inspect the wiring connections.

Note: Luminaires are preset at 3000K & highest wattage (12W, 20W or 25W)

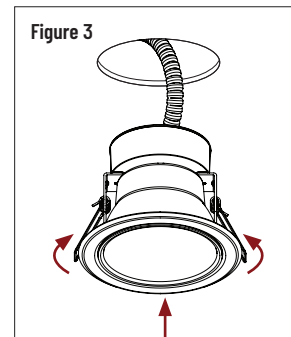
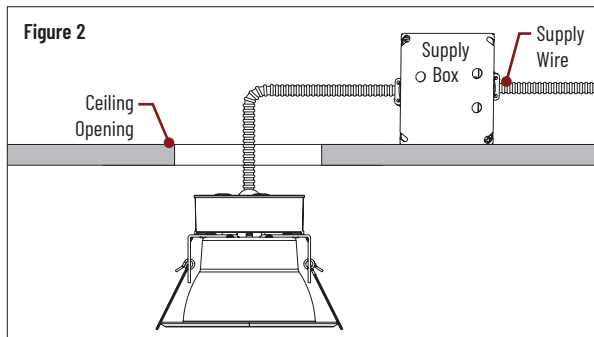
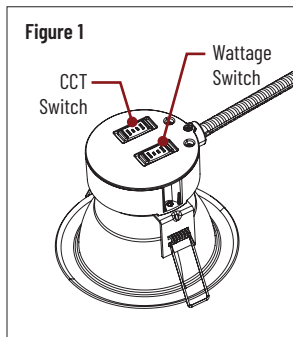

Installation Instructions

NQZ2

Quartz LED Downlight with Selectable Lumens & Selectable CCT

READ PRIOR TO ATTEMPTING INSTALLATION
ALWAYS TURN OFF MAIN POWER BEFORE INSTALLATION
INSTALLATION SHOULD BE CARRIED OUT BY YOUR LOCAL ELECTRICIAN

RETROFIT INSTALLATION

Note: Luminaires are preset at 3000K & highest wattage (12W, 20W or 25W)

1. Turn off power before installation.
2. Before installing the luminaire, set the desired color temperature and wattage located on top of the luminaire. (Figure 1)
3. Remove the existing lamp and trim. (Figure 2)
4. Locate the existing supply box in the ceiling and disconnect the supply wires from the previous lamp.

CAUTION: NQZ2 does not require a protector/sensor. If a thermal protector or insulation sensor was installed from the previous luminaire, disconnect the protector/sensor based off the environmental conditions.

5. Connect the luminaire wires to the existing supply box. (Figure 3) Refer to "Electrical Connections".
6. Lift the spring clips on the luminaire and insert the luminaire into the ceiling (Figure 4).
7. Installation complete, turn on power.

CAUTION: if the luminaire does not turn on within five seconds, turn off power. Remove the luminaire and carefully inspect the wiring connections.

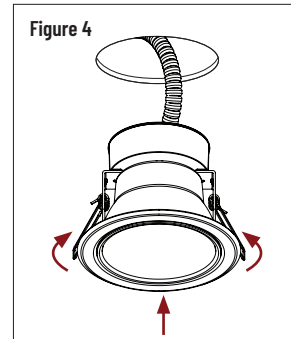
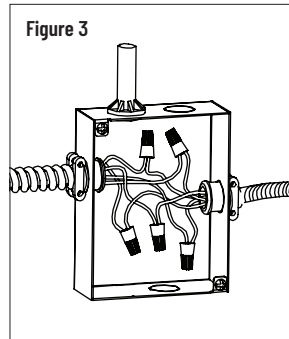
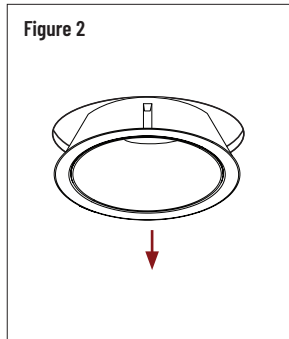
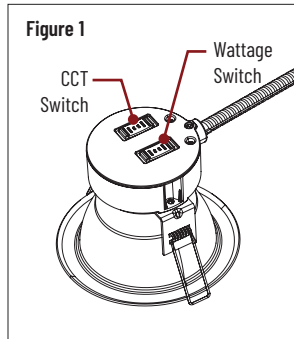

ELECTRICAL CONNECTIONS

0-10V DIMMING CONNECTION:

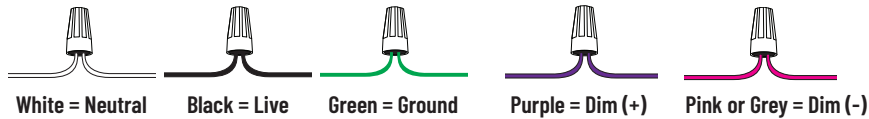

NOTE ON GROUNDING: Many structures carry grounding via steel conduit. If this is the case, if there is no grounding wire, simply leave green wire on fixture attached. Fixture will be grounded through attachment of conduit to junction box. However, if Romex or PVC conduit is used, ground wire will always be present, and must be connected to green wire on fixture junction box to avoid electrical shock hazard.