

LH99IC - IC DOUBLE WALL E26 HOUSING

4" LINE VOLTAGE HOUSINGS

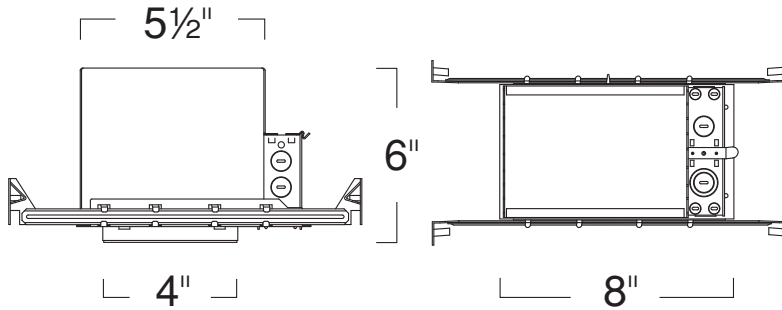

SPECIFICATION

120V 50W Max PAR20/PAR30 MED E26
40W A19

Application: General purpose recessed downlight housing for low to medium height ceilings for residential and light commercial applications. A variety of trims, compatible styles and finishes are available to achieve the desired décor and illumination.

Housing: Pre-wired housing adjusts up to a 1 1/4" ceiling thickness. Integral thermal protector to guard against improper lamping and installation. Housing provides an adjustable socket plate which allows for use of different lamp types. Trim is secured with torsion wing springs.

Mounting: Housing suitable for new construction installations only, supplied with (2) 24" adjustable hanger bars with 90 degrees repositioning ability. Hanger bars equipped with nail-less install 3/4" serrated barbed studs and with captive nails, for faster and easier secure mounting in wood joists. Set-screws lock into position and prevent shifting after installation. Earthquake structural cable compatible for drop panel ceiling or any other mounting that requires direct support from structural ceilings.

Socket: Standard porcelain medium screw base socket with high temperature leads.

Junction Box : 16 gauge pre-wired galvanized steel Junction Box, 32 cubic-inch for a maximum of (8) #12 AWG wires. Furnished with (7) 3/4" and (4) Romex knock-outs. Strain clamps to install or remove covers for easy access and ground wire. Equipped with safety standard fitting for flex-conduit.















Insulation Contact: IC rated housing rated for direct contact with low to medium density loosefill blown and rolled insulation. For use with high density loosefill blown insulation, reduce rated lamp wattage accordingly (roughly %15-%20).

Airflow: Airtight option is designed to restrict air flow from room into plenums in compliance to the WSEC - Washington State Energy Code, (Less than 2.0 CFM -Cubic Feet per Minute). Complies to Title24 air flow requirements (Air-tight).

Safety Labels: UL/CUL listed for through-branch wiring (8) No.12 AWG 90°C and suitable for damp locations. NYC approved: Calendar #41937.

Label: UL Listed, cETL Listed

COMPATIBILITY

 LR987 ADJUSTABLE REFLECTOR	 LRLD442 4" 120V DECO DOME RETROFIT (NON-DIMMING)	 LR934 PINHOLE W/ BAFFLE
 LR993 PHENOLIC BAFFLE	 LRS923 FRESNEL LENS W/ REFLECTOR	 LR946 DECO GLASS-SHIELD (DOME)
 LR994 DEEP PHENOLIC BAFFLE	 LR999 SHALLOW REFLECTOR	 LRLD4 4" LED REFLECTOR
 LRS912 PATTERNED GLASS W/ REFLECTOR	 LRS925 FROSTED TRIMS W/ REFLECTOR	 LRLD403 BAFFLE FLAT LENS (DIMMABLE)
 LRELD442 REFLECTOR DOME LENS (DIMMABLE)	 LRLD402 4" 120V BASIC REFLECTOR RETROFIT (NON-DIMMING)	 LRM985 ADJUSTABLE METAL BAFFLE

Please see website for more compatible items.

FEATURE:



LH99IC RATING

LH99IC A :IC-Airtight

ORDERING EXAMPLE : LH99ICA

ID# : 101