

# CL-220-AB

## SPECIFICATION SHEETS

### Fixture Configurations

Down Light .....2

Well Light .....3

Step Light .....4

Underwater Light .....5

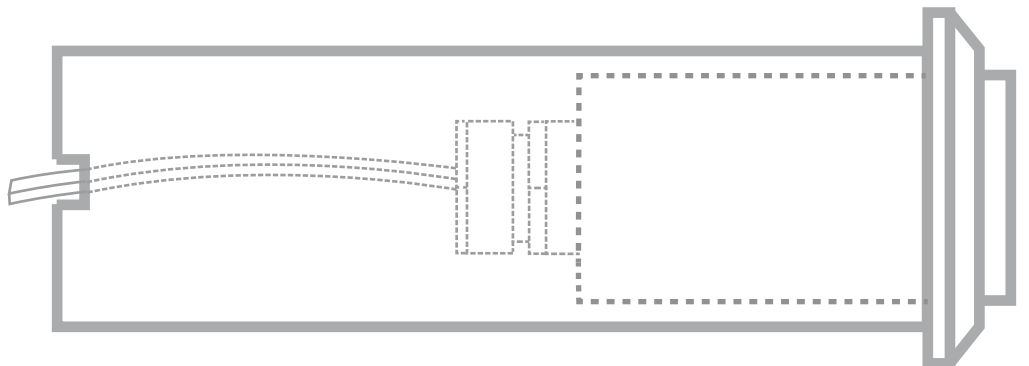
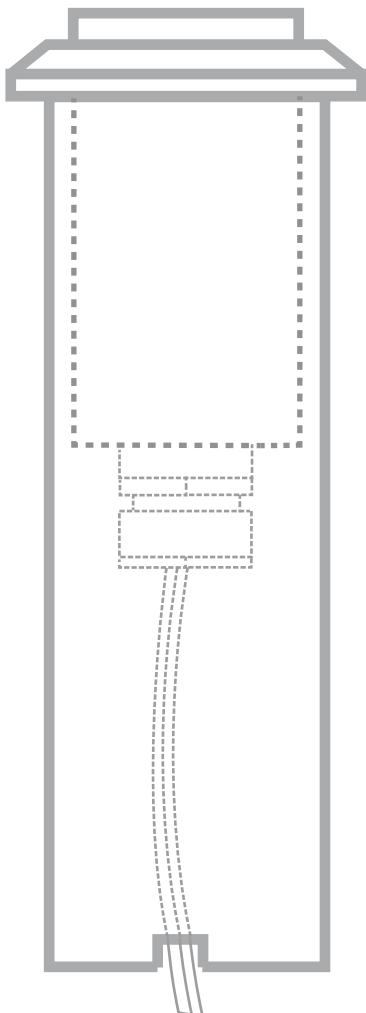

# SPECIFICATION SHEET

## PRODUCT # : CL-220-AB

• Down Lights

• Cast Brass

### Fixture Specifications:

**Housing:** Heavy duty corrosion resistant cast brass with PVC sleeve.

**Faceplate:** Louvered cast brass, fitted to housing with silicone "O" ring gasket.

**Finish:** **AB-** Antique Bronze. Natural toning process. Finishes may vary due to artistic process. Also available in **GM-** Gun Metal, or **SI-** Silver plated.

**Lens:** Clear and heat resistant tempered flat glass.

**Lighting Source:** Integrated CREE LED module, 3 watt, 210 lumens 120° beam spread, 3000K, 20W halogen equivalent. Rated hours: 30,000.

**Wiring:** Fixture is prewired with a 18-2 20ft SPT-1W direct burial cord, pre-stripped for easy connection. Wire connector sold separately. Universal connector (**CX-839**), and silicone filled wire nut (**CX-854**) are available from Corona Lighting.

**Gasket:** Silicone "O" ring, seals faceplate to housing, providing weather tight protection.

**Mounting:** Recessed flush mount. Best used in concrete, brick, or other masonry surface.

**Electrical Notes:** Integrated CREE LED module is dimmable. A remote 12V magnetic transformer is required. Options are available from Corona Lighting. Not for use with electronic transformers. Voltage range for LED module is 8-18 Volt AC. Ambient Temperature: -4°F to 104°F. CRI: Ra > 80 Proper grease/lubricant is suggested on threaded parts during installation process.

**Applications:** Ceilings, eaves, patio covers, or any place where a tiny recessed fixture may fit.

**Warranty:** Limited lifetime warranty on fixture housing and faceplate against manufacturer's defects. Ten (10) year warranty on LED modules and components.

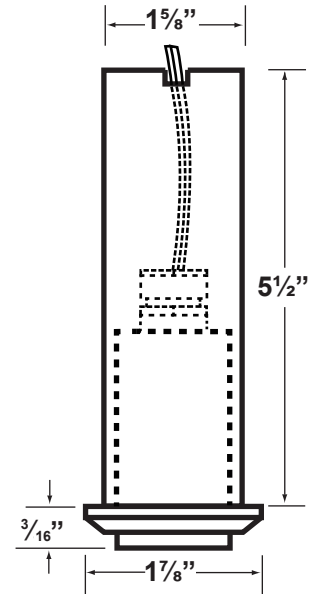
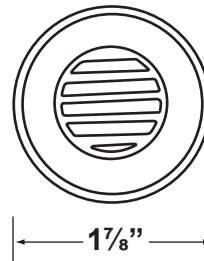

### DESIGNER COLOR LENSES INCLUDED WITH THIS FIXTURE:

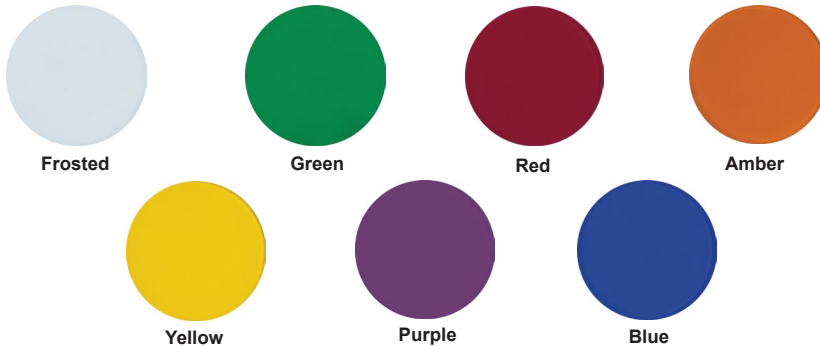

NOTE: Install additional O-ring (supplied) when color lenses are used.

### JOB INFORMATION

TYPE: \_\_\_\_\_ DATE: \_\_\_\_\_

JOB NAME & ADDRESS: \_\_\_\_\_

PRODUCT #: \_\_\_\_\_

TOTAL QUANTITY: \_\_\_\_\_

LAMP TYPE & WATTAGE: \_\_\_\_\_

TRANSFORMER: \_\_\_\_\_

CONTRACTOR: \_\_\_\_\_

SPECIFIER: \_\_\_\_\_

• Corona Lighting reserves the right to make any change and/or improvement to the design and construction of this fixture without further notification.

## PRODUCT # : CL-220-AB

• Well Light

• Cast Brass

### Fixture Specifications:

**Housing:** Heavy duty corrosion resistant cast brass with PVC sleeve.

**Faceplate:** Louvered cast brass, fitted to housing with silicone "O" ring gasket.

**Finish:** **AB-** Antique Bronze. Natural toning process. Finishes may vary due to artistic process. Also available in **GM-** Gun Metal, or **SI-** Silver plated.

**Lens:** Clear and heat resistant tempered flat glass.

**Lighting Source:** Integrated CREE LED module, 3 watt, 210 lumens 120° beam spread, 3000K, 20W halogen equivalent. Rated hours: 30,000.

**Wiring:** Fixture is prewired with a 18-2 20ft SPT-1W direct burial cord, pre-stripped for easy connection. Wire connector sold separately. Silicone filled wire nut (**CX-854**) is available from Corona Lighting.

**Gasket:** Silicone "O" ring, seals faceplate to housing, providing weather tight protection.

**Mounting:** Recessed flush mount. In-ground direct burial or concrete encasement install. Best used in concrete, brick, or other masonry surfaces.

**Electrical Notes:** Integrated CREE LED module is dimmable. A remote 12V magnetic transformer is required. Options are available from Corona Lighting. Not for use with electronic transformers. Voltage range for LED module is 8-18 Volt AC. Ambient Temperature: -4°F to 104°F. CRI: Ra > 80 Proper grease/lubricant is suggested on threaded parts during installation process.

**Applications:** Best used for up lighting, grazing, or backlighting. Install any place where a tiny recessed fixture may fit.

**Warranty:** Limited lifetime warranty on fixture housing and faceplate against manufacturer's defects. Ten (10) year warranty on LED modules and components.

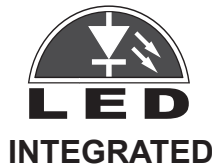
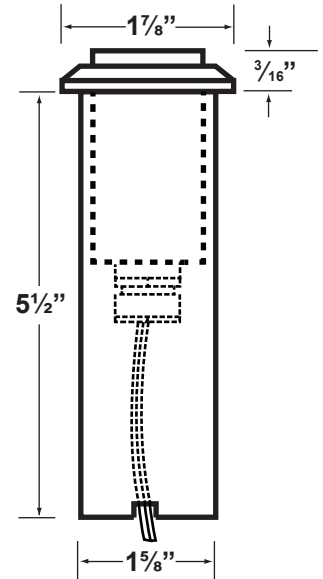

### DESIGNER COLOR LENSES INCLUDED WITH THIS FIXTURE:

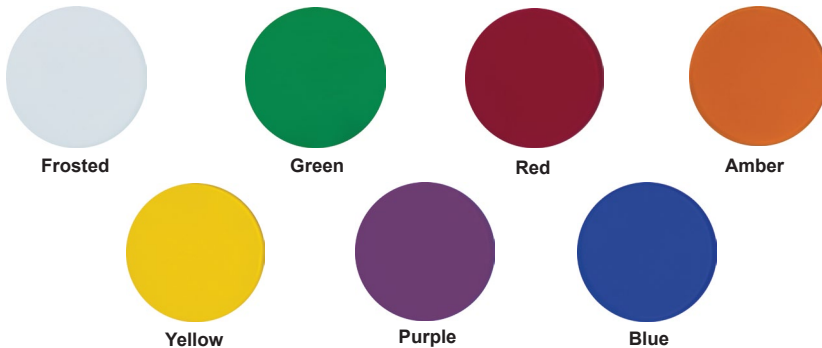

NOTE: Install additional O-ring (supplied) when color lenses are used.

### JOB INFORMATION

TYPE: \_\_\_\_\_ DATE: \_\_\_\_\_

JOB NAME & ADDRESS: \_\_\_\_\_

PRODUCT #: \_\_\_\_\_

TOTAL QUANTITY: \_\_\_\_\_

LAMP TYPE & WATTAGE: \_\_\_\_\_

TRANSFORMER: \_\_\_\_\_

CONTRACTOR: \_\_\_\_\_

SPECIFIER: \_\_\_\_\_

• Corona Lighting reserves the right to make any change and/or improvement to the design and construction of this fixture without further notification.

# SPECIFICATION SHEET

## PRODUCT # : CL-220-AB

• Step Light

• Cast Brass

### Fixture Specifications:

**Housing:** Heavy duty corrosion resistant cast brass with PVC sleeve.

**Faceplate:** Louvered cast brass, fitted to housing with silicone "O" ring gasket.

**Finish:** **AB-** Antique Bronze. Natural toning process. Finishes may vary due to artistic process. Also available in **GM-** Gun Metal, or **SI-** Silver plated.

**Lens:** Clear and heat resistant tempered flat glass.

**Lighting Source:** Integrated CREE LED module, 3 watt, 210 lumens 120° beam spread, 3000K, 20W halogen equivalent. Rated hours: 30,000.

**Wiring:** Fixture is prewired with a 18-2 20ft SPT-1W direct burial cord, pre-stripped for easy connection. Wire connector sold separately. Silicone filled wire nut (**CX-854**) is available from Corona Lighting.

**Gasket:** Silicone "O" ring, seals faceplate to housing, providing weather tight protection.

**Mounting:** Recessed flush mount. Best used in concrete, brick, or other masonry surfaces.

**Electrical Notes:** Integrated CREE LED module is dimmable. A remote 12V magnetic transformer is required. Options are available from Corona Lighting. Not for use with electronic transformers. Voltage range for LED module is 8-18 Volt AC. Ambient Temperature: -4°F to 104°F. CRI: Ra > 80 Proper grease/lubricant is suggested on threaded parts during installation process.

**Applications:** Seat walls, steps, stairs, decking, entry columns, outdoor living spaces, gazebos, or any place where a tiny recessed fixture may fit.

**Warranty:** Limited lifetime warranty on fixture housing and faceplate against manufacturer's defects. Ten (10) year warranty on LED modules and components.

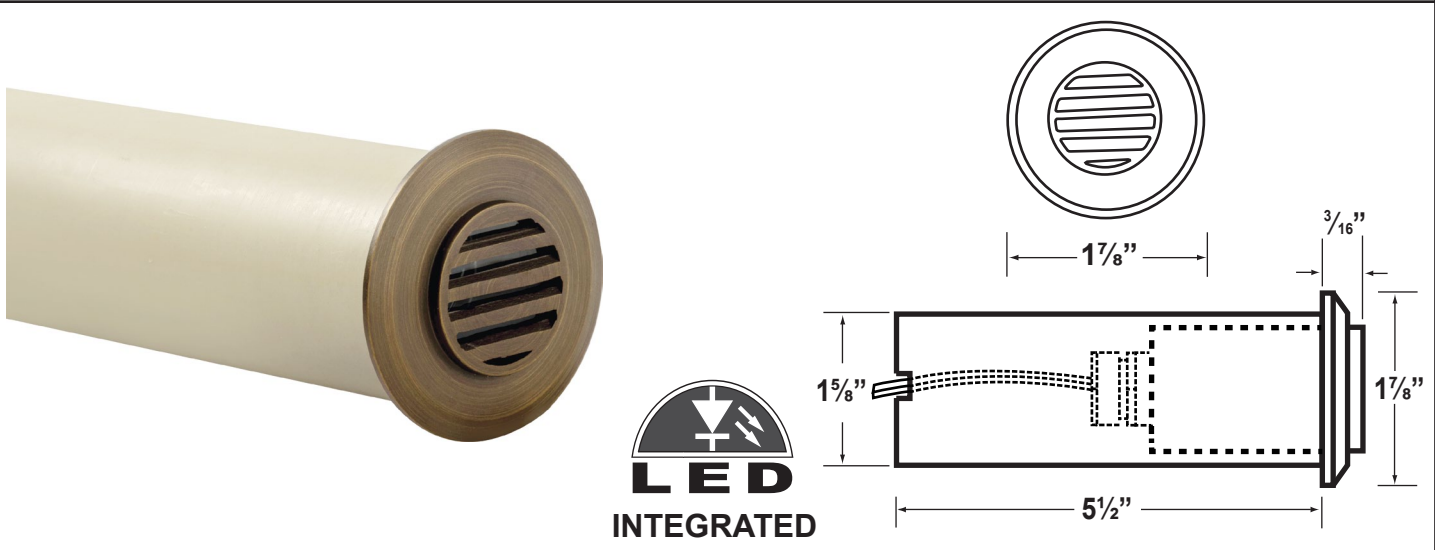

### DESIGNER COLOR LENSES INCLUDED WITH THIS FIXTURE:

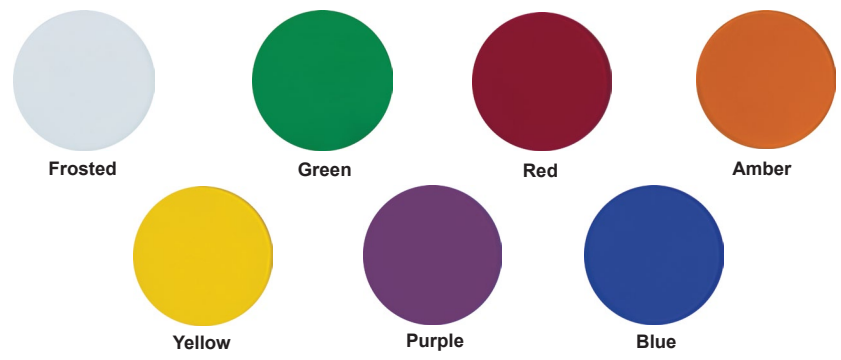

**NOTE:** Install additional O-ring (supplied) when color lenses are used.

### JOB INFORMATION

TYPE: \_\_\_\_\_ DATE: \_\_\_\_\_

JOB NAME & ADDRESS: \_\_\_\_\_

PRODUCT #: \_\_\_\_\_

TOTAL QUANTITY: \_\_\_\_\_

LAMP TYPE & WATTAGE: \_\_\_\_\_

TRANSFORMER: \_\_\_\_\_

CONTRACTOR: \_\_\_\_\_

SPECIFIER: \_\_\_\_\_

• Corona Lighting reserves the right to make any change and/or improvement to the design and construction of this fixture without further notification.

# SPECIFICATION SHEET

## PRODUCT # : CL-220-AB

• Underwater Light

• Cast Brass

### Fixture Specifications:

- Housing:** Heavy duty corrosion resistant cast brass with PVC sleeve.
- Faceplate:** Louvered cast brass, fitted to housing with silicone "O" ring gasket.
- Finish:** **AB-** Antique Bronze. Natural toning process. Finishes may vary due to artistic process. Also available in **GM-** Gun Metal, or **SI-** Silver plated.
- Lens:** Clear and heat resistant tempered flat glass.
- Lighting Source:** Integrated CREE LED module, 3 watt, 210 lumens 120° beam spread, 3000K, 20W halogen equivalent. Rated hours: 30,000.
- Wiring:** Fixture is prewired with a 18-2 20ft SPT-1W direct burial cord, pre-stripped for easy connection.
- Gasket:** Silicone "O" ring, seals faceplate to housing, providing weather tight protection.

- Mounting:** Recessed flush mount.
- Electrical Notes:** Integrated CREE LED module is dimmable. A remote 12V magnetic transformer is required. Options are available from Corona Lighting. Not for use with electronic transformers. Voltage range for LED module is 8-18 Volt AC. Ambient Temperature: -4°F to 104°F. CRI: Ra > 80 Proper grease/lubricant is suggested on threaded parts during installation process.
- Applications:** Fountains, water features, ponds, waterfalls, garden pools, or any place where a tiny recessed fixture may fit.  
  
Only to be used in fresh water. **DO NOT** install in swimming pools, lakes, or spas.
- Warranty:** Limited lifetime warranty on fixture housing and faceplate against manufacturer's defects. Ten (10) year warranty on LED modules and components.

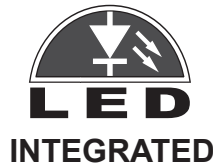
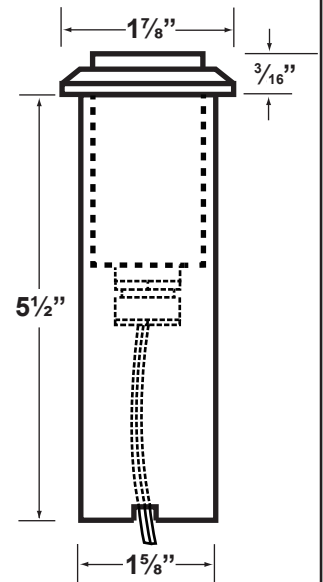
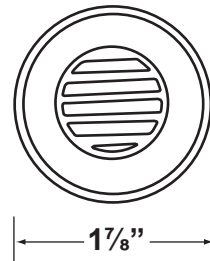

### DESIGNER COLOR LENSES INCLUDED WITH THIS FIXTURE:

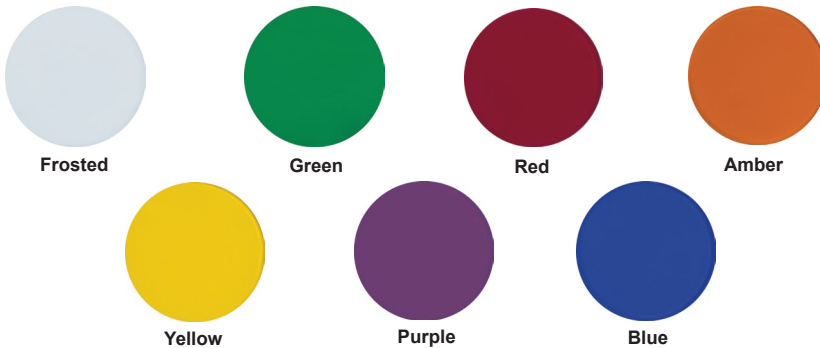

NOTE: Install additional O-ring (supplied) when color lenses are used.

### JOB INFORMATION

TYPE: \_\_\_\_\_ DATE: \_\_\_\_\_  
 JOB NAME & ADDRESS: \_\_\_\_\_  
 PRODUCT #: \_\_\_\_\_  
 TOTAL QUANTITY: \_\_\_\_\_  
 LAMP TYPE & WATTAGE: \_\_\_\_\_  
 TRANSFORMER: \_\_\_\_\_  
 CONTRACTOR: \_\_\_\_\_  
 SPECIFIER: \_\_\_\_\_

• Corona Lighting reserves the right to make any change and/or improvement to the design and construction of this fixture without further notification.