

CL-219-AB

SPECIFICATION SHEETS

Fixture Configurations

Down Light2

Well Light3

Step Light4

Underwater Light5

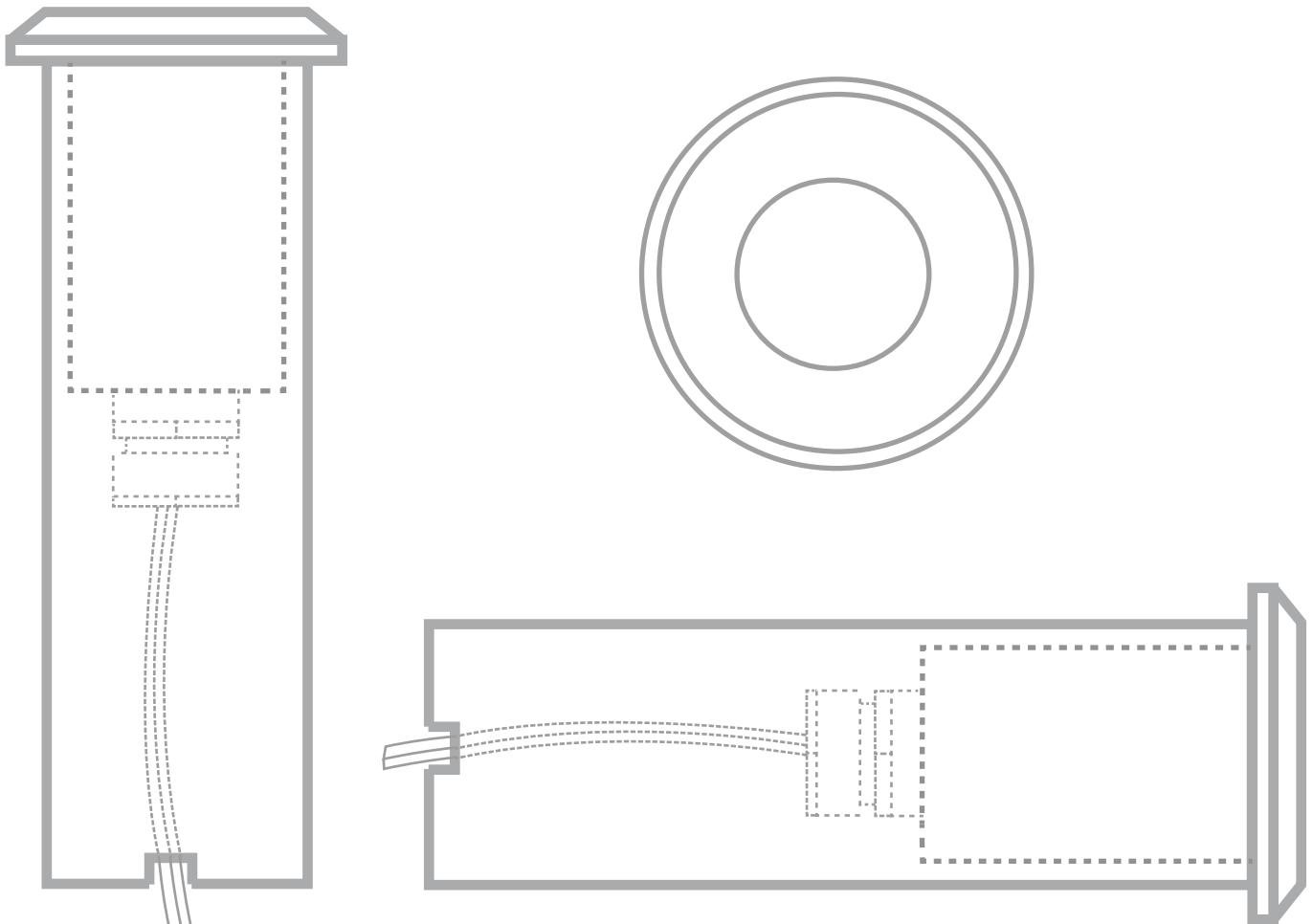

SPECIFICATION SHEET

PRODUCT # : CL-219-AB

• Down Lights

• Cast Brass

Fixture Specifications:

Housing: Heavy duty corrosion resistant cast brass with PVC sleeve.

Faceplate: Cast brass flat shape, fitted to housing with silicone "O" ring gasket.

Finish: **AB-** Antique Bronze. Natural toning process. Finishes may vary due to artistic process. Also available in **GM-** Gun Metal, or **SI-** Silver plated.

Lens: Clear and heat resistant tempered flat glass.

Lighting Source: Integrated CREE LED module, 3 watt, 210 lumens 120° beam spread, 3000K, 20W halogen equivalent. Rated hours: 30,000.

Wiring: Fixture is prewired with a 18-2 20ft SPT-1W direct burial cord, pre-stripped for easy connection. Wire connector sold separately. Universal connector (**CX-839**), and silicone filled wire nut (**CX-854**) are available from Corona Lighting.

Gasket: Silicone "O" ring, seals faceplate to housing, providing weather tight protection.

Mounting: Recessed flush mount. Best used in concrete, brick, or other masonry surface.

Electrical Notes: Integrated CREE LED module is dimmable. A remote 12V magnetic transformer is required. Options are available from Corona Lighting. Not for use with electronic transformers. Voltage range for LED module is 8-18 Volt AC. Ambient Temperature: -4°F to 104°F. CRI: Ra > 80 Proper grease/lubricant is suggested on threaded parts during installation process.

Applications: Ceilings, eaves, patio covers, or any place where a tiny recessed fixture may fit.

Warranty: Limited lifetime warranty on fixture housing and faceplate against manufacturer's defects. Ten (10) year warranty on LED modules and components.

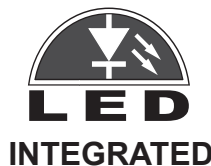
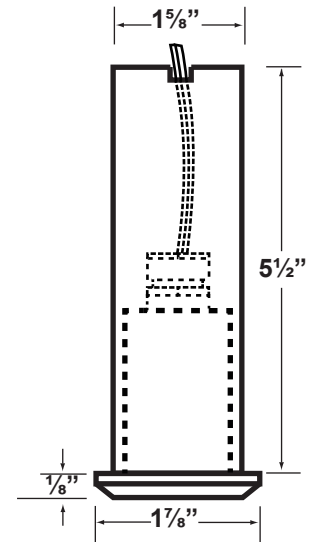
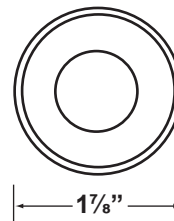

DESIGNER COLOR LENSES INCLUDED WITH THIS FIXTURE:



Frosted



Green



Red

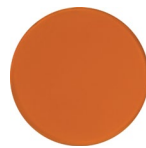

Amber



Yellow

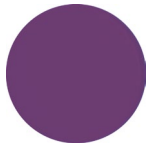

Purple

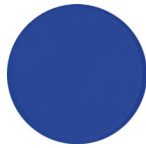

Blue

NOTE: Install additional O-ring (supplied) when color lenses are used.

JOB INFORMATION

TYPE:

DATE:

JOB NAME & ADDRESS:

PRODUCT #:

TOTAL QUANTITY:

LAMP TYPE & WATTAGE:

TRANSFORMER:

CONTRACTOR:

SPECIFIER:

SPECIFICATION SHEET

PRODUCT # : CL-219-AB

• Well Light

• Cast Brass

Fixture Specifications:

- Housing:** Heavy duty corrosion resistant cast brass with PVC sleeve.
- Faceplate:** Cast brass flat shape, fitted to housing with silicone "O" ring gasket.
- Finish:** **AB-** Antique Bronze. Natural toning process. Finishes may vary due to artistic process. Also available in **GM-** Gun Metal, or **SI-** Silver plated.
- Lens:** Clear and heat resistant tempered flat glass.
- Lighting Source:** Integrated CREE LED module, 3 watt, 210 lumens 120° beam spread, 3000K, 20W halogen equivalent. Rated hours: 30,000.
- Wiring:** Fixture is prewired with a 18-2 20ft SPT-1W direct burial cord, pre-stripped for easy connection. Wire connector sold separately. Silicone filled wire nut (**CX-854**) is available from Corona Lighting.
- Gasket:** Silicone "O" ring, seals faceplate to housing, providing weather tight protection.

- Mounting:** Recessed flush mount. In-ground direct burial or concrete encasement install. Best used in concrete, brick, or other masonry surfaces.
- Electrical Notes:** Integrated CREE LED module is dimmable. A remote 12V magnetic transformer is required. Options are available from Corona Lighting. Not for use with electronic transformers. Voltage range for LED module is 8-18 Volt AC. Ambient Temperature: -4°F to 104°F. CRI: Ra > 80 Proper grease/lubricant is suggested on threaded parts during installation process.
- Applications:** Best used for up lighting, grazing, or backlighting. Install any place where a tiny recessed fixture may fit.
- Warranty:** Limited lifetime warranty on fixture housing and faceplate against manufacturer's defects. Ten (10) year warranty on LED modules and components.

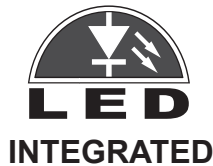
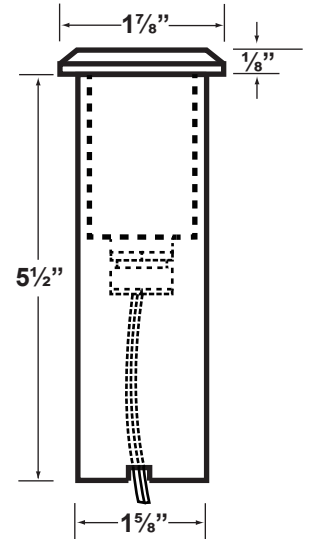
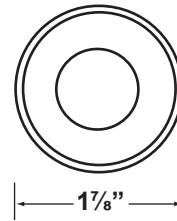

DESIGNER COLOR LENSES INCLUDED WITH THIS FIXTURE:

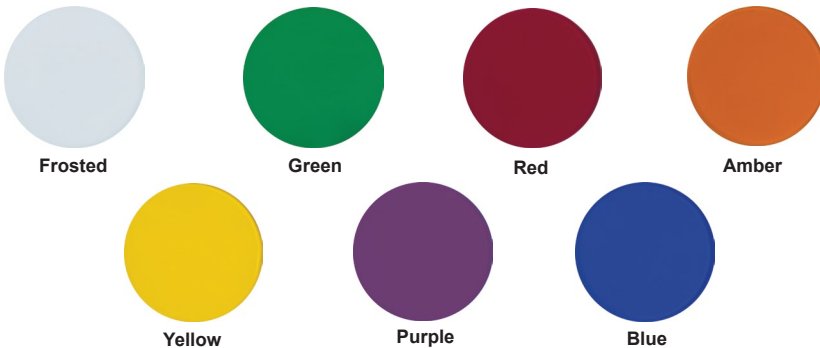

NOTE: Install additional O-ring (supplied) when color lenses are used.

JOB INFORMATION

TYPE: _____ DATE: _____
 JOB NAME & ADDRESS: _____
 PRODUCT #: _____
 TOTAL QUANTITY: _____
 LAMP TYPE & WATTAGE: _____
 TRANSFORMER: _____
 CONTRACTOR: _____
 SPECIFIER: _____

• Corona Lighting reserves the right to make any change and/or improvement to the design and construction of this fixture without further notification.

SPECIFICATION SHEET

PRODUCT # : CL-219-AB

• Step Light

• Cast Brass

Fixture Specifications:

- Housing:** Heavy duty corrosion resistant cast brass with PC sleeve.
- Faceplate:** Cast brass flat shape, fitted to housing with silicone "O" ring gasket.
- Finish:** **AB-** Antique Bronze. Natural toning process. Finishes may vary due to artistic process. Also available in **GM-** Gun Metal, or **SI-** Silver plated.
- Lens:** Clear and heat resistant tempered flat glass.
- Lighting Source:** Integrated CREE LED module, 3 watt, 210 lumens 120° beam spread, 3000K, 20W halogen equivalent. Rated hours: 30,000.
- Wiring:** Fixture is prewired with a 18-2 20ft SPT-1W direct burial cord, pre-stripped for easy connection. Wire connector sold separately. Silicone filled wire nut (**CX-854**) is available from Corona Lighting.
- Gasket:** Silicone "O" ring, seals faceplate to housing, providing weather tight protection.

- Mounting:** Recessed surface or direct burial install. Best used in concrete, brick, or other masonry surfaces.
- Electrical Notes:** Integrated CREE LED module is dimmable. A remote 12V magnetic transformer is required. Options are available from Corona Lighting. Not for use with electronic transformers. Voltage range for LED module is 8-18 Volt AC. Ambient Temperature: -4°F to 104°F. CRI: Ra > 80 Proper grease/lubricant is suggested on threaded parts during installation process.
- Applications:** Seat walls, fountains, steps, ceilings, ponds, patio covers, waterfalls, or any place where a tiny recessed fixture may fit.
- DO NOT** install in swimming pools, lakes, or spas.
- Warranty:** Limited lifetime warranty on fixture housing and faceplate against manufacturer's defects. Ten (10) year warranty on LED modules and components.

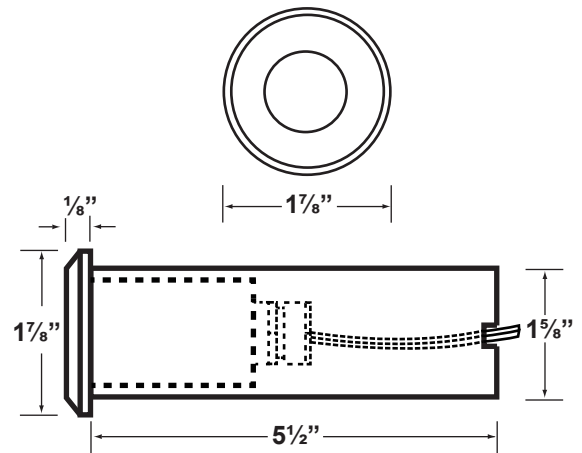
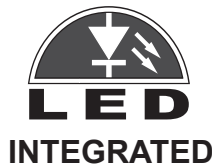

DESIGNER FILTERS INCLUDED WITH THIS FIXTURE:

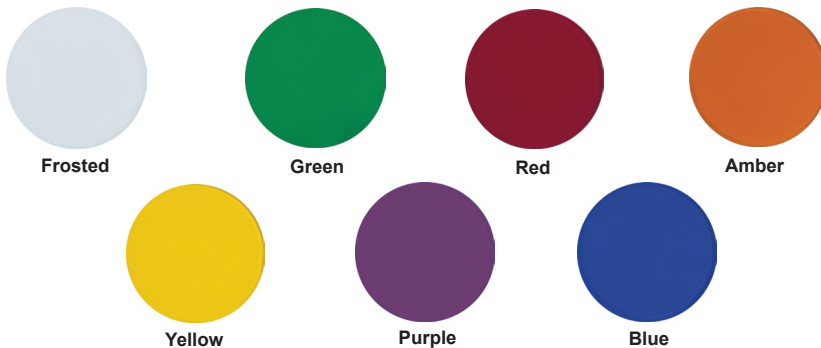

NOTE: Must use additional o-ring (included) to ensure filter to work on fixture.

JOB INFORMATION

TYPE: _____ DATE: _____

JOB NAME & ADDRESS: _____

PRODUCT #:

TOTAL QUANTITY:

LAMP TYPE & WATTAGE:

TRANSFORMER:

CONTRACTOR:

SPECIFIER:

• Corona Lighting reserves the right to make any change and/or improvement to the design and construction of this fixture without further notification.

SPECIFICATION SHEET

PRODUCT # : CL-219-AB

• Underwater Light

• Cast Brass

Fixture Specifications:

- Housing:** Heavy duty corrosion resistant cast brass with PVC sleeve.
- Faceplate:** Cast brass flat shape, fitted to housing with silicone "O" ring gasket.
- Finish:** **AB-** Antique Bronze. Natural toning process. Finishes may vary due to artistic process. Also available in **GM-** Gun Metal, or **SI-** Silver plated.
- Lens:** Clear and heat resistant tempered flat glass.
- Lighting Source:** Integrated CREE LED module, 3 watt, 210 lumens 120° beam spread, 3000K, 20W halogen equivalent. Rated hours: 30,000.
- Wiring:** Fixture is prewired with a 18-2 20ft SPT-1W direct burial cord, pre-stripped for easy connection.
- Gasket:** Silicone "O" ring, seals faceplate to housing, providing weather tight protection.

- Mounting:** Recessed flush mount.
- Electrical Notes:** Integrated CREE LED module is dimmable. A remote 12V magnetic transformer is required. Options are available from Corona Lighting. Not for use with electronic transformers. Voltage range for LED module is 8-18 Volt AC. Ambient Temperature: -4°F to 104°F. CRI: Ra > 80 Proper grease/lubricant is suggested on threaded parts during installation process.
- Applications:** Fountains, water features, ponds, waterfalls, garden pools, or any place where a tiny recessed fixture may fit.

Only to be used in fresh water. **DO NOT** install in swimming pools, lakes, or spas.
- Warranty:** Limited lifetime warranty on fixture housing and faceplate against manufacturer's defects. Ten (10) year warranty on LED modules and components.

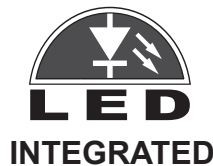
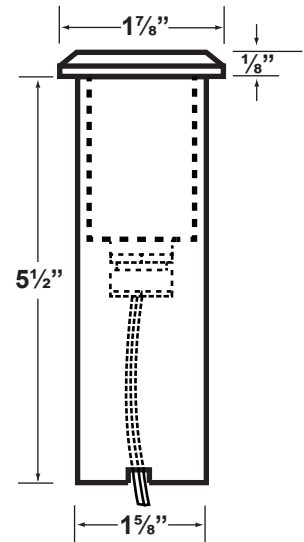
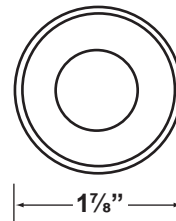

DESIGNER COLOR LENSES INCLUDED WITH THIS FIXTURE:

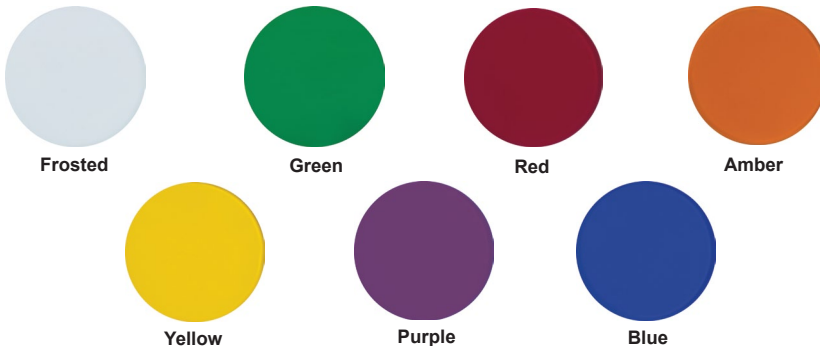

NOTE: Install additional O-ring (supplied) when color lenses are used.

JOB INFORMATION

TYPE: _____ DATE: _____
 JOB NAME & ADDRESS: _____
 PRODUCT #: _____
 TOTAL QUANTITY: _____
 LAMP TYPE & WATTAGE: _____
 TRANSFORMER: _____
 CONTRACTOR: _____
 SPECIFIER: _____

• Corona Lighting reserves the right to make any change and/or improvement to the design and construction of this fixture without further notification.